

User Guide

ecobee3

©2014 ecobee

250 University Ave | Suite 400
Toronto | Ontario | M5H 3E5
Canada Toll free 1.877.932.6233

www.ecobee.com

e3-UG-R001

Table of Contents

Overview	4	Ventilator/HRV/ERV (if installed)	13
Getting Help	4	Adjusting Sensor Modes	13
Touch Screen.....	4	Smart Home/Away.....	13
Web Portal	5	Follow Me	13
Guided Setup Process	5	Adjusting Comfort Settings	14
Step 1. Wiring Configuration.....	5	Setting Your Weekly Schedule	15
Step 2. Accessory Confirmation	5	Going on Vacation.....	16
Step 3. Temperature Preference Setup	6	Caring for your Thermostat.....	17
Step 4. Equipment Configuration	6	Cleaning.....	17
Heat Pumps.....	6	Rebooting	17
Furnaces/Boilers.....	6	Resetting the Thermostat	17
Fans	6	Troubleshooting.....	17
Humidifier.....	6	Reminders & Alerts	18
Dehumidifier.....	6	Viewing Reminders	18
Ventilators (ERV/HRV)	7	Viewing Alerts	18
Step 5. Name Your Thermostat	7	Configuring Reminders & Alert Preferences.....	18
Step 6. Configure Ideal Temperatures.....	7	HVAC Maintenance	18
Step 7. Select Current HVAC System Mode	7	Furnace Filter.....	19
Step 8. Configure Sensor Settings	7	Ventilator Filter (if installed)	19
Step 9. Wi-Fi Configuration	7	UV Lamp	19
Step 10. Date & Time	8	Low Temp Alert	19
Step 11. Web Portal/Mobile App Registration	8	High Temp Alert	19
Basic Functions	9	Aux Heat Runtime Alert	19
Home Screen.....	9	Aux Outdoor Temp Alert	19
Standby Screen.....	9	Low Humidity Alert.....	19
Adjusting the Temperature	9	High Humidity Alert.....	19
Main Menu.....	10	Display Alerts on Thermostat.....	19
Quick Changes	10	Enable Heating/Cooling Alerts.....	19
Weather	11	Lost Communication With Sensor/Low Battery Alerts	20
System Icons	11	Customizing Your Thermostat.....	20
Selecting System Operation Mode	11	Date & Time	20
HVAC System	11	Temperature Display.....	20
Fan.....	12	Heating/Cooling Ranges	21
Humidifier (if installed).....	12	Thermostat Name	21
Dehumidifier (if installed).....	12	Screen Brightness	21
		Active to Standby Screen Timer	21
		Hold Action Duration.....	21

Smart Recovery	22
Access Control	22
Configuring Wi-Fi Settings	23
Wi-Fi Radio	23
Network	23
Advanced Settings	23
Diagnostics.....	23
Managing Your Account	24
Registering	24
Making Changes to Your Account	24
Moving to New House	24
Changing Thermostat Owner	24
Installation Settings	24
Equipment Wiring.....	24
Equipment Settings	24
Heat Pump	24
Furnace.....	25
Humidifier.....	25
Dehumidifier.....	25
Ventilator	26
Reconfiguring Equipment	26
Thresholds.....	26
Auto Heat/Cool.....	26
Heat/Cool Min Delta	26
Compressor Min Cycle Off Time.....	26
Compressor Min Outdoor Temp.....	26
AC Overcool Max	27
Aux Heat Max Temp	27
Heat Differential Temp.....	27
Heat Dissipation Time.....	27
Heat Min On Time.....	27
Cool Differential Temp.....	27
Cool Dissipation Time	28
Cool Min On Time.....	28
Compressor Reverse Staging.....	28
Compressor Stage 2 Temp Delta	28
Compressor Stage 1 Max Runtime	28

Compressor to Aux Temp Delta	28
Compressor to Aux Runtime	29
Temperature Correction.....	29
Installer Code.....	29
Test Equipment	29
Wiring Diagrams	30
Conventional heating and cooling	30
Heat Only.....	30
Heat and Cool.....	30
Heat and Cool (2 Stage Heat)	30
Heat pumps	31
Air or Geothermal Heat Pump with Auxiliary Heat	31
Air or Geothermal Heat Pump (2 Stages) with Auxiliary Heat	31
Boiler or radiant systems.....	31
Boiler or Radiant System with Air Handler and Conventional Cooling or Heat Pump.....	31
Boiler or Radiant System (2 stages) with Air Handler and Conventional Cooling or Heat Pump.....	32
Accessory devices	32
PEK thermostat wiring	32
Icon Reference	33
Home Screen	33
System Operation	33
Menus	33
Comfort Settings.....	33
Weather.....	33
WiFi Connectivity.....	33
Menu Reference	33
Approvals	35
FCC Compliance Statement	35
3-Year Limited Warranty	36
End User Software License Agreement	37

Overview

Do you hear that?

That's the sound of hundreds of thousands of ecobee-ers welcoming you to the hive.

Congratulations on the purchase of your new ecobee3 smarter wi-fi thermostat with remote sensor. This guide will provide an overview of the features and capabilities of the new product and will help you get up and running.

Make sure you also take a look at the Quick Start Guide and the Installation Guide that come in the box with your ecobee3.

- **Remote sensors** – Deliver the right temperature in the rooms that matter most as well as detect when these rooms are occupied.
- **Smart** – Your ecobee3 understands your home's unique energy profile and the weather outside, making sure you're comfortable at all times.
- **Intuitive** – With its 3.5" full color touch display, your ecobee3 has intuitive controls just like your smartphone.
- **Accessible from anywhere** – Monitor and control the temperature in your home anytime, anywhere, on your smartphone, tablet, or computer.

Getting Help

If you have any questions, we have answers. Visit <https://www.ecobee.com/faqs/ecobee-3> for tutorials, how-to videos and FAQs.

Technical support is also available by email or by phone:

support@ecobee.com
1.877.932.6233 (North America)
1.647.428.2220 (International)

Touch Screen

Your ecobee3 has a touch screen, similar to that used in smartphones and tablets.



Touch items to select or activate them. For menus with a >, this will expand the menu to display additional options or submenus.



Swipe up and down to display additional information. Swiping on a temperature bar will also adjust the settings up or down.



Swipe left and right to scroll horizontal lists that contain multiple items to choose from.

Exit or go back

To exit a submenu, touch <. To close the main menu, touch ∨.

Web Portal

Once registered (page 8), you can log in to your web portal and manage your ecobee3 from your computer or tablet.

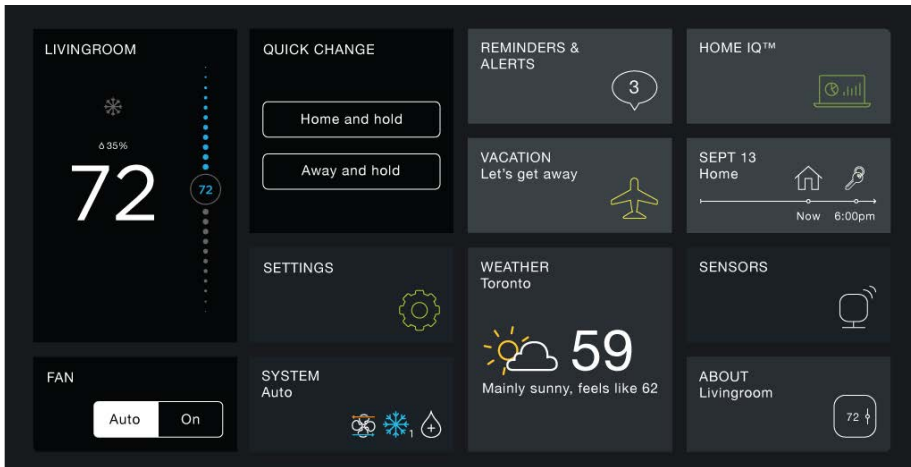

From the web portal, you can:

- Control current temperature and operation
- Adjust your schedule
- Set vacation periods
- View the weather forecast for your area
- Set thermostat preferences
- Manage all your ecobee thermostats
- Save energy with HomeIQ and insights

To access your customized web portal, visit **ecobee.com** and click on the **Login** link.

To select a file, touch or click on it. To close a file and return back to the main screen, touch or click  (top-right corner).

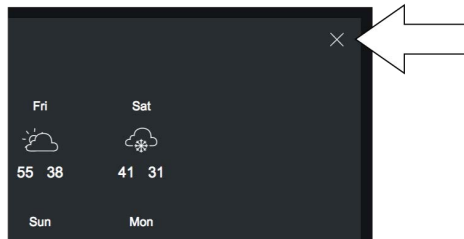

Guided Setup Process

The Installation Guide that ships with your ecobee has the necessary instructions to wire up and install your device. After installing your ecobee3 thermostat on the wall and powering it up, you will be guided through the first-run process. Complete these steps to get it configured and connected online so you can make use of all its smart features.

This will take you through the following steps:

- Wiring configuration and equipment configuration
- Setting your preferences
- Wi-Fi configuration
- Registering your ecobee3

If you make a mistake at any time or want to review a setting, you can touch Back to display the previous screen.

Step 1. Wiring Configuration

Your ecobee3 automatically detects and displays which wires are connected to it when it first powers on. It will warn you if you've wired a configuration that it doesn't recognize.

If the reported connections are different than what you have actually connected, call ecobee support for guidance.

Touch Next to continue.

Step 2. Accessory Confirmation

Your ecobee3 will ask if you have any accessories like humidifier, dehumidifier, or ventilator connected to it.

Touch Yes if you have one of these devices; otherwise touch No.

If you selected Yes, you will need to specify if the accessory is internally powered:

- Touch Yes if your accessory is externally powered (i.e. the ecobee3 does not provide power to it). This is the case if there are connected to both ACC+ and ACC-.

- Touch No if your accessory receives power from your ecobee3. There will be a single wire to ACC+.

Need Help? See page 32 for information on how to determine your accessory device's power configuration.

Touch Next to continue.

Step 3. Temperature Preference Setup

Your ecobee3 will ask you to select Fahrenheit or Celsius as your preferred temperature units. Touch Next to continue.

Step 4. Equipment Configuration

Your ecobee3 will ask you to configure your equipment. Depending on your wiring, different options will be available. These options will configure basic system operation as well as optimize the system for your specific type of equipment.

Review the list to see if any devices require additional configuration ("Configuration needed") and if the default settings are valid.

Once you are done, touch Next to continue.

Heat Pumps

If you have a heat pump installed:

1. Select the heat pump menu.
2. Select Air to Air or Geothermal depending on the type of your heat pump system
3. Specify what the heat pump runs when the O/B Reversing Valve is engaged: On Cool runs cooling when O/B engages (most cases), or On Heat runs heating when O/B engages.
4. Touch Next. You will be returned to the Equipment configuration menu.

Furnaces/Boilers

If you have a furnace or boiler installed:

1. Select the heating menu.

2. Configure the heater type:

- Furnace: Optimizes ecobee3 for systems using forced air
- Boiler: Optimizes your ecobee3 for systems using radiators or in-floor heat.

3. Touch Next. You will be returned to the Equipment configuration menu.

Fans

If your furnace uses forced air, you may configure fan operation:

1. Select Fan menu.
2. Select Fan operation:
 - Thermostat: Your ecobee3 thermostat controls the fan during heat and cool cycles.
 - HVAC: Your equipment controls the fan during heat and cool cycles (typical configuration).
3. Touch Next. You will be returned to the Equipment configuration menu.

Humidifier

If you have a humidifier installed:

1. Select Accessory menu.
2. Select Humidifier.
3. Touch Next.
4. Select the type of humidifier you have: Evaporative or Steam. If unsure, select Evaporative.
5. Touch Next. You will be returned to the Equipment configuration menu.

Dehumidifier

If you have a dehumidifier installed:

1. Select Accessory menu.
2. Select Dehumidifier.

3. Touch Next.
4. Select Open if the dehumidifier is active when the relay is open; otherwise select Closed. If unsure, select Closed (if the dehumidifier runs when it shouldn't, you can change this option in the Equipment Configuration menu (page 24).
5. Touch Next. You will be returned to the Equipment configuration menu.

Ventilators (ERV/HRV)

If you have a ventilator (ventilator, ERV or HRV) installed:

1. Select Accessory menu.
2. Select Ventilator.
3. Touch Next.
4. Select the type of ventilator you have installed: Ventilator, Energy Recovery Ventilator or Heat Recovery Ventilator.
5. Touch Next.
6. Select the preferred minimum runtime (min/hr) when your home is occupied and the runtime for when your home is unoccupied. If unsure, keep the default 20 min/hr value or contact a professional.
7. For HRVs, select whether or not you would like to use it to use it to dehumidify in winter.
8. For Ventilators, select whether or not you would like to enable free cooling.
9. Touch Next. You will be returned to the Equipment configuration menu.

Step 5. Name Your Thermostat

After configuring your equipment, you will be prompted to give your ecobee3 a name. Select a name from the list or enter your own using the on-screen keyboard.

This name will appear in your web portal, so pick a name that makes it easy to identify your thermostat (this is especially important if you have more than one in your house).

Touch Next to continue.

Step 6. Configure Ideal Temperatures

Next, slide the set-point bubble up and down to select the preferred, normal temperature for your home during winter and summer (touch Next after each). This setting will be used to generate the default comfort settings.

Step 7. Select Current HVAC System Mode

Select the operating mode of your HVAC equipment. For example, if you want to set your HVAC system to heat, select Heat. If you do not want the system to run, select Off.

Touch Next to continue.

Step 8. Configure Sensor Settings

Your ecobee3 includes sensors that can determine when you are home. You can have your thermostat automatically go into energy savings mode when you are away. For a detailed description of how the settings work, see page 13.

1. Enable or disable Smart Home/Away setting.
If enabled, your ecobee3 senses when you are home during a scheduled Away period, or away during a scheduled Home period, and will automatically override your scheduled settings to maximize comfort and savings.
2. Touch Next to continue.

Step 9. Wi-Fi Configuration

To get the most out of your ecobee3, it needs to connect to your home's Wi-Fi network.

Touch Next to configure your network settings. If you do not want the ecobee3 to connect to the Internet, touch Skip and confirm the action by pressing Next.

When configuring your network settings, your ecobee3 will display a list of all visible Wi-Fi networks along with their signal strength. If your network has weak signal strength, try moving your router closer to the ecobee3.

If your network appears in the list

1. Select your network from the list
2. Touch Next.
3. Enter your password, if prompted.
4. After connecting to the Internet, your ecobee3 will register itself with the ecobee servers and provide you with a 4-digit registration code.
5. Write down the 4-digit code. **You will need it when registering your ecobee3 (You can register from either ecobee's Mobile App or Web Portal).**

If it's not listed, select *My network is not visible* and touch Next (you will have to enter your network parameters manually, including the SSID).

1. If your network is password-protected, enter the password.
2. This will take you through the manual Wi-Fi set-up process where you will have to enter in information about your network such as if it's a DHCP or a static IP, the network SSID name, the encryption, the password etc.
3. After connecting to the Internet, your ecobee3 will register itself with the ecobee servers and provide you with a 4-digit code.
4. Write down the 4-digit code. **You will need it when registering your ecobee3 (You can register from either ecobee's Mobile App or Web Portal).**

Touch Next to continue.

Step 10. Date & Time

The Date & Time screen lets you configure your time zone settings. If you didn't configure Wi-Fi in the previous step, you may need to reconfigure the current time and date. These settings are required in order for the scheduling features of your ecobee3 to work properly.

If Wi-Fi is configured:

1. Touch Time zone.
2. Select your country from the list and touch Next.

3. Select your time zone by picking the name of the nearest community from the list.
4. Touch Next.
5. Touch Next to continue.

If Wi-Fi is not configured:

1. Touch Date.
2. Slide up and down to set the current date and touch Save
3. Touch Time.
4. Slide up and down to set the current time and touch Save.
5. Touch Time zone.
6. Select your country from the list and touch Next.
7. Select your time zone by picking the name of the nearest community from the list.
8. Touch Next.
9. Touch Next to continue.

Step 11. Web Portal/Mobile App Registration

After setting up Wi-Fi on your ecobee3 and obtaining the registration code, you need to configure your account from either the ecobee3 Mobile App or the Web Portal.

To register from the Web Portal:

1. From a web browser, visit www.ecobee.com
2. Click on the **Register** link.
3. Follow the on-screen instructions to register your account.

To register from the Mobile App:

1. Download the app to your iPhone or Android device from the respective app store.
2. Launch the ecobee3 app.
3. Follow the on-screen instructions to register your account.

Basic Functions

The bright, easy-to-read touch screen on your ecobee3 thermostat makes it simple to review and adjust settings any time you want.

Home Screen

Your ecobee3 will automatically display the home screen when you approach it.

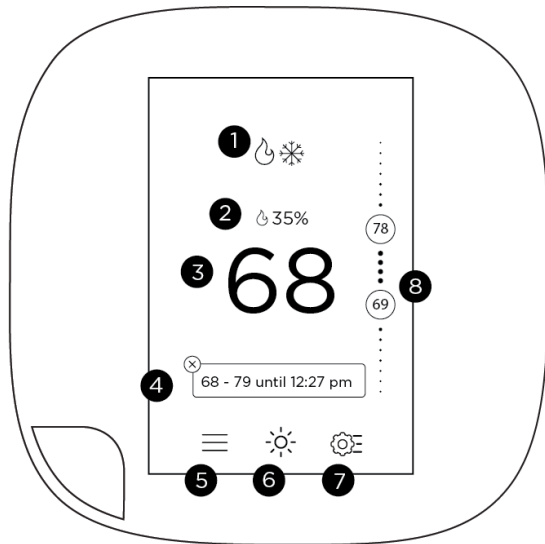

- 1 Current system mode and any equipment currently running
- 2 Current relative humidity
- 3 Current indoor temperature
- 4 Messages indicating any special operating mode or state (e.g. resume, temperature hold, etc)
- 5 Main menu. If a dot appears on the icon, you have important message(s) to read.
- 6 Weather forecast

- 7 Quick Change menu
- 8 Adjustable heat and cool set points. If the System Mode is set Auto, both are displayed; otherwise only heat or cool is displayed.

Standby Screen

The standby screen activates whenever the thermostat is not in use. It shows the current indoor temperature and outdoor weather conditions.

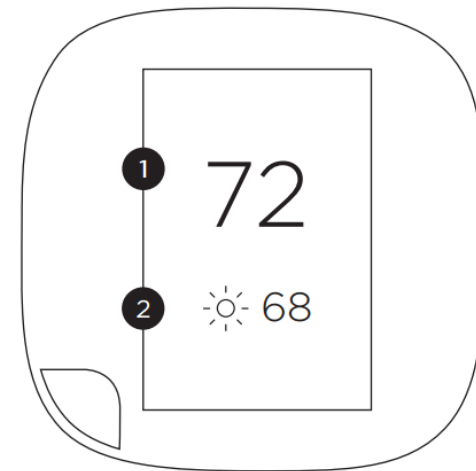

- 1 Current indoor temperature
- 2 Current outdoor weather and temperature

The standby screen is configurable. You can adjust:

- Standby screen activation time (page 21)
- Standby screen brightness (page 21)

Adjusting the Temperature

You can override the scheduled temperature by moving the bubble on the temperature slider up or down. The blue number









represents the cool set point; the orange number represents the heat set point.

The new desired temperature will be the set point used for the Hold. The duration of the Hold is the last configured value (the default value is Until I change it, meaning it keeps the value indefinitely, until you choose to revert to the schedule or change it). You can adjust the default Hold time in the Preferences menu (page 21).

To cancel the current Hold, touch the Hold message box displayed on the Home screen. You can touch the box anywhere and not just the X displayed on the box.

Main Menu

To show the main menu, touch the screen and touch ☰.

	Registration	Registers your ecobee3. This menu item disappears after you have registered.
	System	Selects mode of operation: heat/cool/auto, fan on/off, and any accessory (page 11)
	Sensors	Manages sensors and lets you adjust Smart Home/Away and Follow Me settings (page 13)
	Schedule	Manages temperature according to time and day (page 15)
	Comfort Settings	Manages temperature for different climate states (Away, Home, Sleep) (page 14)
	Vacation	Manages thermostat settings for a vacation period (page 16)
	Reminders & Alerts	Displays any reminder or alert messages (page 18)
	Settings	Manages display preferences (°F/°C, date, brightness), Wi-Fi, and equipment operating parameters (thresholds,

sensors, etc) (page 20)



About

Displays technical information about your thermostat (page 17).

Quick Changes

The Quick Changes screen lets you quickly adjust the operation of the ecobee3 and your equipment.

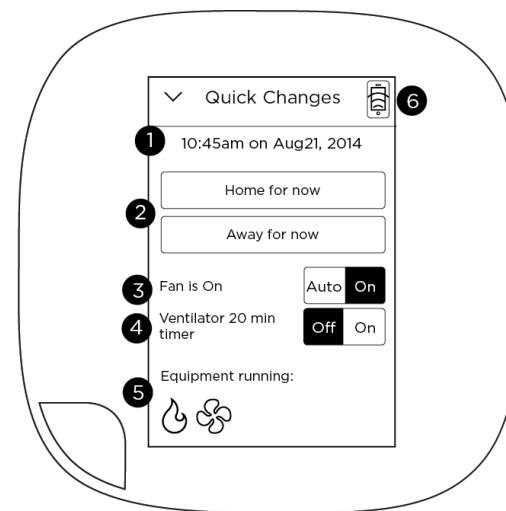

- 1 Current time and date display
- 2 Home and Away buttons. Touch these buttons to override your programmed schedule. To cancel this action, touch the message box on the Home screen.
- 3 Toggle fan between Auto and On. Touch On to run the fan continuously. Touch Auto to run the fan according to the Minimum Runtime per Hour setting (page 24).
- 4 If you have a ventilator, ERV or HRV installed, touch On to run the device for 20 minutes (page 26)
- 5 Icons indicate if heat, cool, fan, and any accessories are actively running (see page 11)

for icon descriptions)

- Internet connection and ecobee server connection status. If this icon is red, you can contact our technical support team for help (page 4).

Hint: You can also apply quick changes from the web portal by clicking on the Fan or Quick Changes tiles.

Weather

Touch the Weather icon to display a local weather forecast for the week as well as a detailed daily forecast.

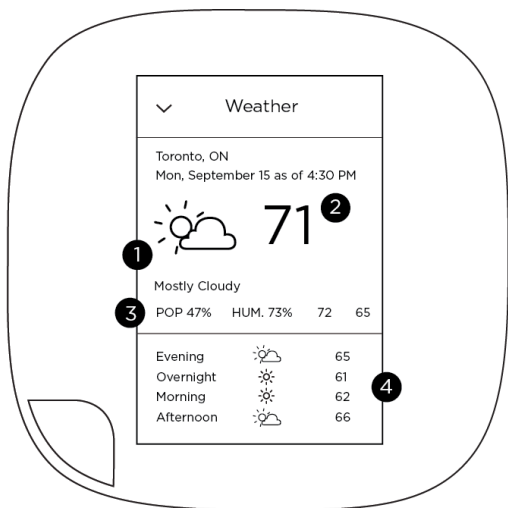





- Current weather conditions
- Current outdoor temperature
- Probability of precipitation (POP), relative humidity, and daily high/low temperature
- 24-hour weather forecast

Note: To receive the local weather forecast, you must first register your thermostat (page 22). For a complete list of weather icons, see page 33.

System Icons

The icons on the Home screen and Quick Changes menu show information about the status of your HVAC system.

-  Heat: An orange heat icon indicates that your thermostat is calling for heat. A white heat icon indicates that your system is in heat or auto mode but is not currently calling for heat.
-  Cool: A blue cool icon indicates that your thermostat is calling for cool. A white cool icon indicates that your system is in cool or auto mode but is not currently calling for cool.
-  Fan: A fan icon indicates that your thermostat is calling for the fan to run.
-  Auto: If both heat and cool icons are shown, your system is in Auto mode, meaning your ecobee3 will call for heat or cool as required.

Selecting System Operation Mode

The System menu controls the basic operation of the different components in your HVAC system, including the heat/cool mode, fan operation, and the operation of accessories like humidifiers, dehumidifiers, and ventilators.

HVAC System

The HVAC System settings depend on the type of system you have. Depending on your system, one or more the following options are shown:

- Cool: Turn on the air conditioner when the current temperature rises above the set temperature.
- Heat: Turn on the heat when the current temperature drops below the set temperature.
- Auto: Activate the heating or cooling system as required to keep your home within the configured range of set temperatures.

- **Aux:** Only use the auxiliary or backup heat source to maintain the heat set point temperature. *This option only appears if auxiliary heat is configured in the Equipment menu.*
- **Off:** Turn the system off. When the system is off, only the current temperature will be displayed on the Home screen.

On Thermostat and Mobile:

Select Main Menu > System > HVAC System

On Web:

Select System tile > HVAC

Fan

The Fan menu displays the current furnace fan setting. Depending on your system, one or more of the following options are shown:

- **On:** Force fan to run continuously, regardless of the scheduled programming. The fan will also run if the System Mode is Off.
- **Auto:** Enable fan when the system is actively heating or cooling your home, or to satisfy the Minimum Fan Runtime setting (page 12).

On Thermostat and Mobile:

Select Main Menu > Quick Changes > Fan

On Web:

Select Fan tile

Minimum Fan Runtime (Auto mode only)

When the fan is in Auto mode, ecobee3 operates it according to the Minimum Fan Runtime setting. You can adjust this setting from 0 to 55 minutes.

When your system is in heat or cool mode, the fan will always run for this minimum amount of time. A longer runtime improves air circulation and results in a more consistent temperature than with the Auto setting while being more cost-effective than the On setting.

Your ecobee3 will meet this minimum runtime over the hour while making sure it never runs for less than five minutes.

On Thermostat and Mobile:

1. Select Main Menu > System > Fan
2. Swipe left or right to adjust the value.

On Web:

1. Select System Tile > Fan
2. Swipe or drag left or right to adjust the value.

Humidifier (if installed)

The Humidifier menu enables or disables the humidifier, if installed:

- **On:** Run the humidifier to increase the humidity to the configured set point.
- **Off:** Do not operate the humidifier.
- **Frost control:** Automatically maintain the humidity to stay comfortable but prevent condensation or frost on your windows

To adjust the humidity set point and other options, see page 14.

On Thermostat and Mobile:

Select Main Menu > System > Humidifier

On Web:

Select System tile > Humidifier

Dehumidifier (if installed)

The Dehumidifier menu enables or disables the dehumidifier, if installed:

- **On:** Run the dehumidifier to reduce the humidity to the configured set point.
- **Off:** Do not operate the dehumidifier.

To adjust the dehumidifier set point, see page 12.

On Thermostat and Mobile:

Select Main Menu > System > Dehumidifier

On Web:

Select System tile > Dehumidifier

Ventilator/HRV/ERV (if installed)

The Ventilator/HRV/ERV menu configures the operation of a ventilator, a Heat Recovery Ventilator (HRV) or an Energy Recovery Ventilator (ERV), if installed:

- Occupied minimum runtime: Configure how many minutes per hour the device will run during occupied periods, such as when you're home or asleep.
- Unoccupied minimum runtime: Configure how many minutes per hour the device will run during unoccupied periods, such as when you're away.

Ventilation devices are important to maintain indoor air quality and, depending on where you live, this might be regulated. The amount of indoor air required to maintain sufficient indoor air quality depends on how big your house is, how many people live there, and the capacity of your ventilation device. You should consult with a local contractor who can guide you on how often you should be running your ventilation device.

For devices configured as ventilators (i.e. not HRVs or ERVs) you can enable a feature called "free cooling" on your ecobee3. When the outdoor temperatures are cooler than indoors and your system is calling for cool, your ecobee3 will turn on your ventilator to bring in outdoor air instead of running your air conditioner. To configure free cooling options, see page 26.

On Thermostat and Mobile:

1. Select Main Menu > System > Ventilator/HRV/ERV
2. Adjust the Occupied Min Run Time and Unoccupied Min Run Time by selecting each option and swiping left or right to adjust the values.
3. If supported by your device, enable or disable Free Cooling.

On Web:

1. Select System tile > Ventilator/HRV/ERV

2. Adjust the Occupied Min Run Time and Unoccupied Min Run Time by selecting each option and swiping left or right to adjust the values.
3. If supported by your device, enable or disable Free Cooling.

Adjusting Sensor Modes

Your ecobee3 supports wireless remote sensors that detect motion and temperature in different rooms (one was included with your thermostat). Your ecobee3 also has a built-in motion sensor. With these sensors, you can optimize the operation of your thermostat to ensure comfort in the rooms and times that matter most.

For information about installing new sensors, see the ecobee Installation Guide, or the documentation included with the sensor itself.

Smart Home/Away

Smart Home/Away applies all the sensors in your network – including the sensors built-in your thermostat. It works by following your schedule unless any sensor in your network is in conflict with your schedule. In other words, if your ecobee3 senses that you are home during a scheduled Away period, or away during a scheduled Home period, it will automatically override your schedule by placing you in Smart Home/Away mode to maximize comfort (Smart Home) and savings (Smart Away).

On Thermostat:

1. Select Main Menu > Sensors > Smart Home/Away
2. Touch Enable to have your sensor network and thermostat detect occupancy. To have your thermostat strictly follow your programmed schedule, touch Disable.

Follow Me

Follow Me is a feature that applies to a selected group of the sensors in your network (including the sensor built-in your thermostat). It works by looking for motion triggered by any of

the selected sensors. If motion is detected, the temperature reading from that sensor will be used by your ecobee3 to decide when to operate your heating or cooling system. This ensures that you are comfortable in the rooms that you are occupying. If more than one sensor detects motion, the average of these sensors will be used. Your ecobee3 makes changes gradually when many sensors are detecting motion to make sure there are no sudden or large changes for your heating and cooling system to deal with.

When Follow Me is disabled, your ecobee3 will continuously use the average temperature readings from all the sensors that you've selected as the desired temperature to control your ecobee3. For example, suppose you have a room in your house that is far from your thermostat and you want this room to be at the thermostat's set temperature, regardless if motion is occurring. In this case, set Follow Me to Disable and only select this room. Your ecobee3 will now only use the temperature in this room to decide when to operate your heating or cooling system.

On Thermostat:

1. Select Main Menu > Sensors > Follow Me
2. Enable or disable the Follow Me feature.
3. If enabled, select which sensors are affected by pressing on each checkbox.

Adjusting Comfort Settings

You can configure your ecobee3 to fit your schedule and comfort needs while maximizing your energy savings.

Your ecobee3 organizes your temperature and fan settings into different Comfort Settings. These settings are used in the Schedule, Smart Home and Quick Changes menus

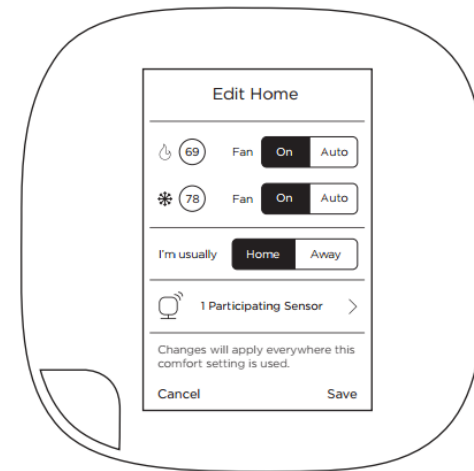

By default, your ecobee3 includes three configurable Comfort Settings:

- **Away:** Settings for when you are not at home.
- **Home:** The normally settings for when you are at home and awake.
- **Sleep:** Settings for when you are sleeping.

Note: You can create new Comfort Settings (or remove them) from the Web Portal.

On Thermostat and Mobile:

1. Select Main Menu > Comfort Settings
2. Select the Comfort Setting you want to customize.
3. Adjust the set points for heat and cool, as well as fan mode as required.
4. You can also now select which sensors are participating in this comfort setting.
5. Touch Save.

On Web:

1. Select Schedule file.
2. Select the Comfort Setting you want to customize, or select New Comfort Setting to add a new one.
3. Adjust the name, set points for heat and cool, as well as fan mode as required.

4. Select if this Comfort Setting is for when the home is Occupied or Unoccupied.
5. Select Save. The new Comfort Setting will appear in the Schedule tile as well as on the thermostat itself.

To delete a Comfort Setting:

1. Select Schedule tile.
2. Select the Comfort Setting you want to delete.
3. Select Delete.
4. Confirm by selecting Delete.

Setting Your Weekly Schedule

Your heating and cooling needs change depending on the time of day, day of the week, as well as when you are home or away. For example, if there's no one in the house during the workday you might want to let the temperature go up in the summer, to reduce energy used by the air conditioning system, and down in the winter, to reduce heating energy.

The ecobee3 adapts to how your home and heating and cooling equipment perform. Intelligent algorithms combine weather data, your equipment run times and occupancy schedules to optimize performance and maximize energy savings. This means you can be comfortable when you are home and save money when you are not.



On Thermostat and Mobile:

1. Select Main Menu > Schedule
2. Touch the day of the week you want to adjust.
3. Select an existing scheduled activity to edit. You can also create a new activity by touching +.
4. Select Start time.
5. Swipe to select the new time value. *Note: You can only select time values that are at least 30 min after the previous activity to 30 min before the next scheduled activity (i.e. you cannot overlap activity times).*
6. Touch Save.
7. If you have added a new activity, you need to select Comfort Setting to use.
8. Touch Save.
9. Touch the Back arrow to return to the Schedule screen where you can make additional changes as required.

Hint: You can copy the entire schedule from one day to another day (for example, if all your week days follow the same schedule). Display the first day, touch the copy button, select which days to apply the changes to, and touch Save.

On Web:

To edit an existing activity:

1. Select Schedule tile.
2. Select an existing scheduled activity to edit.
3. Select Start time.
4. Select Save.

To create a new activity:

1. On the Schedule tile, select Add activity.
2. Select the day.
3. Select Next.
4. Select the Comfort Setting to use during the activity.
5. Select Next.
6. Select Start time.
7. Select Save.

To copy the entire schedule from one day to another day (for example, if all your week days follow the same schedule):

1. On the Schedule tile, select Copy.
2. Select the day to copy.
3. Select Next.
4. Select the days that will use the copied schedule (you can select more than one).
5. Select Save.

Going on Vacation

Your ecobee3's Vacation feature helps you conserve energy while you are away for extended periods of time. It also ensures your home is comfortable when you return.

A vacation event has a start date and time, as well as an end date and time. You can enter any number of vacations, as long as each has a unique start time.

The Vacation feature overrides your programmed schedule – you can leave your Schedule settings as-is when you go away for a special or unscheduled trip.



On Thermostat and Mobile:

1. Select Main Menu > Vacation
2. Touch + to create a new vacation event.
3. Select Vacation schedule.

4. Enter the Departure date and time.
5. Touch the Back arrow.
6. Select Vacation settings.
7. Select Heat or Cool to enable/disable heat and cool during the vacation event.
8. Configure the set point(s) for heat and/or cool during the vacation event by selecting Heat set to or Cool set to, adjusting the temperature, and then pressing Save.
9. Touch the Back arrow.
10. Touch Save.

The vacation event is now set. You can adjust it at any time by selecting it from the Vacation menu.

To delete a vacation event:

1. Select Main Menu > Vacation
2. Select the vacation you want to delete.
3. Touch Remove .
4. Confirm the deletion by pressing Delete.

On Web:

1. Select Vacation tile.
2. Select New Vacation
3. Enter the depart and return date and times
4. Select Heat and Cool.
5. Enable or disable heat and cool during the period as required.
6. Select the set points for heat and/or cool.
7. Select Save.
8. Select Fan and set the minimum fan run time per hour, if different than your normal settings.
9. Select Save.

The vacation event is now set. You can adjust it at any time by selecting it from the Vacation tile.

Caring for your Thermostat

Cleaning

You can clean your ecobee3 screen by spraying water on to a clean, microfiber cloth. Wipe the surface of the screen with the dampened cloth.

Note: Never spray any liquids directly onto your ecobee3.

Rebooting

You can reboot your ecobee3 by gently pulling the thermostat from the back plate. To pull the thermostat off the wall, make sure you that firmly hold on to the black front of the thermostat. Ensure that you are not pulling the white trim plate as that is attached to the wall.

Rebooting will not alter programming or configuration options.

Resetting the Thermostat

At some point during the life of your ecobee3 thermostat you may want to quickly reconfigure it or restore it to the default state.

- **Reset Registration:** Deletes your registration settings (i.e. username and password). Equipment settings and personal preferences are kept as-is.
- **Reset Preferences:** Resets all your preferences, reminders, alerts and programming back to the default state.
- **Reset All:** Resets the thermostat back to its default factory settings and removes any registration information.

On Thermostat:

1. Select Main Menu > Settings > Reset
2. Select a reset option:
 - Reset Registration
 - Reset Preferences
 - Reset All
3. Touch Yes to confirm the reset.

Troubleshooting

The About menu shows technical information about your ecobee3, including:

- Thermostat name
- Software version
- Serial number
- Contact information for support
- Wi-Fi settings

This information is useful when troubleshooting network issues or contacting ecobee technical support.

On Thermostat or Mobile:

Select Main Menu > About

On Web:

Select About tile.

Reminders & Alerts

The Reminders and Alerts list displays the reminders and alerts that help you know if you need to attend to your HVAC system or when to perform periodic maintenance.

NOTE: To use and receive email alerts, this thermostat must be connected to the Internet via Wi-Fi and the end-user must have a valid email address.

Viewing Reminders

The Reminders list displays the reminders and alerts that help the homeowner know when to perform periodic maintenance.

On Thermostat and Mobile:

1. Select Main Menu > Reminders & Alerts > Reminders
2. Select the reminder you want to view.
3. For example, if you receive a Furnace Filter or UV Lamp Change reminder and you have changed the filter or lamp, or arranged to have your equipment serviced, touch Filter/Lamp Changed or Service Scheduled; otherwise touch the Back arrow.

Hint: If the frequency of the reminder is not correct, touch Edit when viewing the reminder to adjust the settings as required.

On Web:

1. Select Reminders & Alerts tile.
2. Select Reminders.

Viewing Alerts

Your ecobee3 can generate alerts if the temperature in the home goes over or under a pre-programmed level. This protects the home from damage due to freezing and/or excessive heat.

This alert, along with optional technician contact information, will be displayed on the screen. If the homeowner registers the thermostat, the alert will be emailed to them and be displayed on the web portal.

On Thermostat and Mobile:

1. Select Main Menu > Reminders & Alerts > Alerts
2. Select the alert you want to view.
3. Touch OK to return to the Alert list.

Hint: If the alert is not configured correctly, touch Edit when viewing the alert to adjust the settings as required.

On Web:

1. Select Reminders & Alerts tile.
2. Select Alerts.

Configuring Reminders & Alert Preferences

You can configure how and when your ecobee3 generates reminders and alerts.

Note: Only the options relevant to your equipment are shown in the thermostat menus.

On Thermostat and Mobile:

1. Select Main Menu > Reminders & Alerts > Preferences
2. Configure each reminder/alert setting as required.

On Web:

1. Select Reminders & Alerts tile.
2. Select Preferences.
3. Configure each reminder/alert setting as required.

HVAC Maintenance

The HVAC Service (maintenance) reminder generates an alert telling the homeowner that regularly scheduled maintenance is required.

This reminder, along with technician contact information, can be displayed on the screen. If homeowners register their thermostats, the reminders will be emailed to them and be displayed in the web portal.

You can set the Last Service date, turn the Reminder On or Off, and set the Frequency of the maintenance interval in months.

Furnace Filter

Generates an alert that indicates it is time to clean or replace the filter on the furnace, if installed. You can set the Last Filter Change date, turn the Reminder On or Off, and set the Frequency of the maintenance interval.

Ventilator Filter (if installed)

Generates an alert that indicates it is time to clean or replace the filter on the ventilator, if installed. You can set the Last Filter Change date, turn the Reminder On or Off, and set the Frequency of the maintenance interval.

UV Lamp

If the HVAC system uses a UV lamp for air purification, your ecobee3 can generate an alert indicating that it is time to clean or replace the lamp. You can set the Last Lamp Change date, turn the Reminder On or Off, and set the Frequency of the maintenance interval.

Low Temp Alert

Sets the temperature at which the thermostat will generate a Low Temperature Alert. The range can be:

- Enable/Disable: Configures if alert is shown on thermostat.
- A temperature range of 35 to 68 °F (1.5 to 20 °C).

High Temp Alert

Sets the temperature at which the thermostat will generate a High Temperature Alert. The options are:

- Enable/Disable: Configures if alert is shown on thermostat.
- A temperature range of 60 to 104 °F (15.5 to 40 °C).

Aux Heat Runtime Alert

Sets the amount of time that the Auxiliary heat source, if installed, is can run continuously before an alert is generated. The options are:

- Disabled: No alert will be generated.
- A time from 30 min to 8 hrs

Aux Outdoor Temp Alert

If you have a heat pump with an auxiliary heat configuration, you can configure your ecobee3 to generate an alert if the auxiliary heat is called for when the outdoor temperature exceeds this programmed set point. The programmed set point can be between 32 to 80 °F (0 to 26.5 °C)

This feature requires an Internet connection to function properly.

Low Humidity Alert

Sets the percentage of relative indoor humidity at which the ecobee3 will generate a Low Humidity Alert. The options are:

- Off: No alert will be generated.
- A humidity range of 5% to 95%.

High Humidity Alert

Sets the percentage of relative indoor humidity at which the ecobee3 will generate a High Humidity Alert. The options are:

- Off: No alert will be generated.
- A humidity range of 5% to 95%.

Display Alerts on Thermostat

Select Disable if you do not want any of the alerts to be displayed on the ecobee3 thermostat screen. Alerts will continue to be displayed on the web portal and sent via email.

Enable Heating/Cooling Alerts

Select Disable to disable alerts for heat/cool error conditions. If disabled, alerts indicating that the system failed to heat or cool will not appear in the screen, web portal, or emails.

Lost Communication With Sensor/Low Battery Alerts

Select Disable to disable alerts when sensor battery is low or communication with the sensor is lost.

Customizing Your Thermostat

You can customize the operation and display of your ecobee3 to suit your personal preferences.

Note: System settings are only configurable from the thermostat itself, not the Mobile App. Some settings, where indicated, are also configurable from the Web Portal.

Date & Time

You can configure the time to use a 12 or 24-hour format.

Note: The current date and time are programmed during initial setup and automatically from the Internet. If you need to adjust the data and time, log in to your personalized web portal.

On Thermostat:

To adjust the time format:

1. Select Main Menu > Settings > Date & time
2. Select Time format.
3. Touch 12 hr or 24 hr.

On Web:

1. Select Settings tile.
2. Select Time.
3. Select 12 Hour or 25 Hour.

Temperature Display

You can configure the ecobee3 to display the temperature values in Fahrenheit or Celsius.

On Thermostat:

1. Select Main Menu > Settings > Preferences
2. Select Temperature display.
3. Touch °F or °C.

On Web:

1. Select Settings tile.
2. Select Preferences.
3. Select Temperature Display.
4. Select Fahrenheit or Celsius.

Heating/Cooling Ranges

You can configure the ecobee3 to only display a specific heat and/or cool set point range. This prevents users from selecting values outside the displayed range.

On Thermostat:

1. Select Main Menu > Settings > Preferences
2. Select Heating range or Cooling range.
3. Adjust the allowed upper and lower values.
4. Touch Save.

On Web:

1. Select Settings tile.
2. Select Preferences.
3. Select Heat Set Point Range or Cool Set Point Range.
4. Set the allowed upper and lower values by sliding the values left or right.

Thermostat Name

You can customize the name of your ecobee3 to suit your needs (i.e. Main Floor). This is useful if you have multiple systems or zones and are accessing your thermostat from your personalized web portal.

On Thermostat:

1. Select Main Menu > Settings > Preferences
2. Select Thermostat name.
3. Select an existing name from the list or choose Enter your own.
4. Touch Save.
5. If you choose your own name, enter the custom name and touch Save.

Screen Brightness

You can customize the brightness of your ecobee3's screen. The brightness for both the active and standby screens can be configured independently. You can also configure the screen to automatically sleep (i.e. turn off) whenever your ecobee3 enters the Sleep activity period.

For example, if your thermostat is located in a bedroom, you may want to blank the screen when you are sleeping, whereas if the thermostat is in a hallway, you may want the screen displayed all the time.

On Thermostat:

1. Select Main Menu > Settings > Preferences
2. Select Screen brightness.
3. Adjust the values of the Active and Standby screen brightness.
4. Select Screen sleeps when I sleep if you want to make the screen blank during the Sleep activity period.

Active to Standby Screen Timer

You can configure how long it takes for the standby screen to activate after you have finished using the thermostat.

On Thermostat:

1. Select Main Menu > Settings > Preferences
2. Select Active to standby screen timer.
3. Adjust the activation time as required.

On Web:

1. Select Settings tile.
2. Select Preferences.
3. Select Active to Standby Sleep Timer.
4. Select the length of time before the screen sleeps by sliding the values left or right.

Hold Action Duration

You can configure how long a manual change to the set point will remain in effect.

On Thermostat:

1. Select Main Menu > Settings > Preferences
2. Select Hold action.
3. Select the hold action from the list:
 - 2 hours
 - 4 hours
 - Until the next scheduled activity

- Until you change it (default value)
- Decide at time of change

On Web:

1. Select Settings tile.
2. Select Preferences.
3. Select Hold Action.
4. Select the hold action from the list:
 - 2 hours
 - 4 hours
 - Until the next scheduled activity
 - Until you change it (default value)
 - Decide at time of change

Smart Recovery

Smart recovery lets your ecobee3 learn how your heating and cooling system works, taking into account weather and historical operating performance so that your home reaches the scheduled set point at the time in which the change occurs (i.e. not afterwards). For example, if you wake up at 6:00 AM, you do not need to schedule your Home period to start at 5:30 AM. Smart Recovery will start the HVAC equipment to ensure that at 6:00 AM, the house is at your desired temperature.

On Thermostat:

1. Select Main Menu > Settings > Preferences
2. Select Heating Smart Recovery or Cooling Smart Recovery.
3. Touch Enable or Disable.

On Web:

1. Select Settings tile.
2. Select Preferences.
3. Select Smart Recover Heat Mode or Smart Recovery Cool Mode.
4. Select Enable or Disable.

Access Control

You can prevent people from making changes your thermostat's schedule, vacation, or system settings by

configuring a 4-digit security code. If enabled, the security code will be required to access and change these settings.

On Thermostat:

To add a security code or change existing settings:

1. Select Main Menu > Settings > Access control
2. If the security code is currently disabled (default setting), touch Enable Security Code, enter a new code and touch Save.

Otherwise, enter the existing security code.
3. Select the feature(s) you want to protect:
 - Temperature & Quick Changes
 - Schedule
 - Vacation
 - System & Settings

To remove an existing security code:

1. Select Main Menu > Settings > Access control
2. Enter the existing security code.
3. Touch Change Security Code.
4. Delete the existing code and touch Save.

On Web:

1. Select Settings tile.
2. Select Access Control.
3. If the security code is currently disabled (default setting), select Enable and enter a new code and touch Save.

Otherwise, enter the existing security code.
4. Select the feature(s) you want to protect:
 - Temperature & Quick Changes
 - Schedule
 - Vacation
 - System & Settings

Configuring Wi-Fi Settings

Your ecobee3 supports Wi-Fi 802.11 b/g/n. Wi-Fi is normally configured during initial setup. You may, however, be required to reconfigure the settings if your Wi-Fi network settings change.

On Thermostat:

Select Main Menu > Settings > Wi-Fi.

Wi-Fi Radio

Select Enabled to use Wi-Fi. Your ecobee3 needs to connect to Internet for features like the Weather Forecast to work.

Network

The list of available networks appears in the Network menu. If your network doesn't appear, you can enter the SSID manually by selecting My network is not visible.

After selecting or entering the SSID, you can configure the following parameters:

- **Connect to IP using:** Select DHCP to automatically connector, or select Static IP to type in your own values (if unsure, leave DHCP Enabled).
- **SSID Encryption:** ecobee3 supports WEP, WEP128, WPA, and WPA2 encryption schemes.
- **Password** (if encryption is used)
- **Channel:** Leave Any channel selected unless your network is configured to use a specific Wi-Fi channel.

Advanced Settings

If you are using Static IP addressing, the following additional parameters will require configuration:

- **IP Address**
- **Gateway**
- **Subnet Mask**
- **Primary and Secondary DNS**

If you need to specify your ecobee3's MAC address in your router's configuration, you can obtain it from Main Menu > About > Wi-Fi.

Diagnostics

Your ecobee3 contains extensive diagnostic tools to help troubleshoot issues:

- **View Log:** Displays log file information about Wi-Fi operation.
- **Ping Gateway:** Checks to see if the network gateway is responding.
- **Ping ecobee.com:** Checks to see if the ecobee servers are responding.
- **Ping Address:** Checks to see if the entered IP address is responding.
- **Wi-Fi:** Displays the current Wi-Fi network settings.

On Thermostat:

1. Select Main Menu > Settings > Wi-Fi.
2. Select Diagnostics.
3. Run the required diagnostic tool.

Managing Your Account

Your ecobee3 is designed to securely communicate over the Internet with ecobee servers in order to obtain precise weather information and provide your own personalized ecobee web portal.

Registering

To access all the features of your ecobee3, register your ecobee3 at ecobee.com. After registration, you can control your ecobee3 from your smartphone, tablet or desktop, and access free online energy management tools.

Making Changes to Your Account

To make changes to your account, visit ecobee.com and log in to your personalized web portal. From there you will be able to make changes to your account, contact information and location. You will also be able to access additional features for your ecobee3 as well as online energy management tools.

Moving to New House

If you're moving and want to take your ecobee3 with you, you'll need to re-connect it to the Internet and update your location and house information.

Changing Thermostat Owner

If you're moving and are not taking your ecobee3 with you, log onto the Web Portal and select Reset under the Settings tab.

Select Reset Registration. This terminates the association between your ecobee3 thermostat and your personalized web portal. You can also accomplish the same thing by resetting the registration your thermostat (page 17).

You can always add another device for your new home with the same account.

The new homeowners will need to register the ecobee3 thermostat and set up their own web portal.

Installation Settings

The ecobee3 automatically detects which wires are connected to it. However, you may need to still adjust equipment operating parameters.

Note: Installation settings are only configurable from the thermostat itself, not the personalized web portal.

Equipment Wiring

The ecobee3 automatically detects which wires are connected and displays them on the screen.

On Thermostat:

Select Main Menu > Settings > Installation Settings > Equipment > Wiring.

Equipment Settings

The Equipment settings let you configure the devices connected to the thermostat. Depending on your system's equipment, not all options may be available.

Heat Pump

This menu lets you configure a heat pump with up to 2 heat/2 cool stages and a 2 stage auxiliary heat source.

- **Type:** This setting helps the thermostat determine optimum performance and default settings. Select Geothermal if you are using a geothermal heat pump; otherwise select Air to Air.
- **O/B Reversing Value:** Select Energized on Cool to activate the reversing valve output (O/B terminal) when there is a call for cooling. Select Energized on Heat to activate the relay when there is call for heat.
- **Min Cycle off time:** Configures the minimum compressor off time between cycles (240 to 900 seconds).
- **Min outdoor temp:** Disables the compressor when the outside air temperature reaches the configured minimum setting. This performs two functions. It prevents the

compressor from running when the outdoor temperature is too low, thus resulting in damage to the compressor.

You can also set this value to determine when you want the auxiliary heat (if installed) to engage to help meet the set temperature. The temperature range is adjustable from 0 to 65 °F (–17.8 to 18.3 °C) or can be completely disabled.

Note: You need an Internet connection for this feature to operate properly.

- **Aux Heat Simultaneous Operation:** If you select Enable and there is a source of auxiliary heat, it will turn on in addition to the heat pump. The heat pump will be engaged for the first 30 minutes. If, after 30 minutes, the set point has not been met, the auxiliary heat will also be engaged to assist the heat pump in reaching the set point.

If you select Disable, the heat pump will be engaged for up to 2 hours. If after 2 hours the set point has not been met, the thermostat will shutdown the heat pump and engage the auxiliary heat to reach the set point. This option should also be used for installation where the heat pump evaporator coil is downstream from the source of auxiliary heat.

This setting is only available when the Comp to Aux Temp Delta and Comp to Aux Runtime settings are both set to Auto (default).

On Thermostat:

1. Select Main Menu > Settings > Installation Settings > Equipment > Heat Pump.
2. Configure the settings as required.

Furnace

This menu lets you configure up to a 2-stage conventional heat source. If you have selected a heat pump as your primary source, this feature allows you to configure the 1st stage of auxiliary heat connected to the system.

- **Type:** Configured during initial setup (page 4), this optimizes the system for either a conventional furnace or a boiler.

- **Fan control in Heat mode:** Configures the furnace fan to be controlled by the ecobee3 or the HVAC system during heat cycles. Normally the HVAC system controls the fan during heat cycles.

On Thermostat:

1. Select Main Menu > Settings > Installation Settings > Equipment > Furnace.
2. Configure the settings as required.

Humidifier

This menu lets you configure a humidifier accessory.

- **Type:** Optimizes the humidifier operation for either Evaporative or Steam humidification.
- **Min Run Time Delta:** Reduces short cycling by running the humidifier beyond the set point by the selected amount (2% to 10%).
- **Window Efficiency:** The humidifier frost control setting uses this efficiency rating to compute the humidity set point within the range of 15% to 50%. Values are from 1 to 7, with 7 being for the most efficient windows possible.

On Thermostat:

1. Select Main Menu > Settings > Installation Settings > Equipment > Humidifier.
2. Configure the settings as required.

Dehumidifier

This menu lets you configure a dehumidifier accessory.

- **Dehumidify with fan:** Run dehumidifier when fan is running.
- **Min Run time delta:** Reduces short cycling by running the humidifier beyond the set point by the selected amount (2% to 10%).
- **Dehumidify in heat mode:** Select Yes for the humidifier to only operate when there is a call for heat. If you want the humidifier to function at other times, select No.
- **Dehumidifier Active:** Select Open if the dehumidifier is active when the relay is open; otherwise select Closed.

On Thermostat:

1. Select Main Menu > Settings > Installation Settings > Equipment > Dehumidifier.
2. Configure the settings as required.

Ventilator

This menu lets you configure a ventilator accessory.

- **Free Cooling Max Outdoor Temp:** Prevents the free-cooling feature from running when the outdoor temperature is above the configured value.
- **Free Cooling Max Outdoor Humidity:** Prevents the free-cooling feature from running when the outdoor humidity is above the configured value. By default, this option is disabled. The Auto value determines the maximum humidity based on the temperature.
- **Indoor/Outdoor Temp Delta:** The temperature difference between the indoor and outdoor temperatures at which the ventilator will run.
- **Max Set Point Temp Delta:** The maximum allowed difference between the current temperature and set point for free cooling to function. By default, this option is disabled.

On Thermostat:

1. Select Main Menu > Settings > Installation Settings > Equipment > Ventilator.
2. Configure the settings as required.

Reconfiguring Equipment

Select Main Menu > Reconfigure equipment to run the initial setup process again.

Note: Reconfiguring the equipment will delete any existing configuration.

Thresholds

This menu lets you configure the temperature and time thresholds associated with the heating and cooling equipment.

You must configure the Equipment settings (page 24) before setting the thresholds. Only the applicable threshold settings will be displayed (i.e. if no air conditioner is configured, you will not see the options related to air conditioners).

Auto Heat/Cool

Enabling this option allows the user to select auto change-over as a system mode.

On Thermostat:

1. Select Main Menu > Settings > Installation Settings > Thresholds > Auto Heat/Cool.
2. Configure the settings as required.

Heat/Cool Min Delta

The minimum difference between the heat mode set temperature and the cool mode set temperature when the system mode is in auto change-over. The delta is adjustable from 2 to 10 °F (1.1 to 5.5 °C). The default value is 5 °F (2.8 °C).

On Thermostat:

1. Select Main Menu > Settings > Installation Settings > Thresholds > Heat/Cool Min delta.
2. Configure the settings as required.

Compressor Min Cycle Off Time

This enforces a minimum time that the compressor must be off between cycles. This ensures the compressor does not short cycle (which could negatively affect the operating life of the system). This time is adjustable from 240–900 seconds.

On Thermostat:

1. Select Main Menu > Settings > Installation Settings > Thresholds > Compress Min Cycle Off Time.
2. Configure the settings as required.

Compressor Min Outdoor Temp

Enforces a minimum outside air temperature at which the compressor will be disabled. It prevents the compressor from

running when the outdoor temperature is too low, thus resulting in damage to the compressor. If the compressor min outdoor temp is being enforced, auxiliary heat will be used to reach set-point. The temperature range is adjustable from 0 to 65 °F (-17.8 to 18.3 °C) or can be completely disabled. This feature is typically used for air-to-air source heat pumps (35 °F min outdoor temp by default) and is disabled (by default) for geothermal heat pumps.

On Thermostat:

1. Select Main Menu > Settings > Installation Settings > Thresholds > Compressor Min Outdoor Temp.
2. Configure the settings as required.

Note: You need an Internet connection for this feature to operate properly.

AC Overcool Max

Uses the air conditioning to reduce the humidity by cooling beyond the current set point by the configured amount. Note that cooling is still determined by the set point, and the system will not resume cooling until the temperature rises above the current set point. For example, if your cooling set point is 75 F, and this value is set to 2 F, it will allow the AC to overcool to 73 F if the humidity set point has not been met.

On Thermostat:

1. Select Main Menu > Settings > Installation Settings > Thresholds > AC Overcool Max.
2. Configure the settings as required.

Aux Heat Max Temp

Configures the maximum outdoor temperature above which the auxiliary heat will not be engaged. The temperature is adjustable from 0 to 80 °F (26.5 °C) in increments of 0.5°F (0.3°C). The default value is 70°F (21°C).

On Thermostat:

1. Select Main Menu > Settings > Installation Settings > Thresholds > Heat Differential Temp.

2. Configure the settings as required.

Heat Differential Temp

The minimum difference between the current temperature and set temperature before the system calls for heat. A smaller difference means shorter cycle times, whereas a larger difference results in longer cycle times. The temperature range is adjustable from 0 to 3 °F (0 to 1.7 °C) in 0.5°F (0.3°C) increments.

On Thermostat:

1. Select Main Menu > Settings > Installation Settings > Thresholds > Heat Differential Temp.
2. Configure the settings as required.

Heat Dissipation Time

The amount of time the fan will run after the heat set point has been reached and the call for heat has been turned off. Running the fan for a period of time allows for any heated air left in the ducts to circulate throughout the home. The time is adjustable from 0 to 900 seconds. The default value is 30 seconds.

On Thermostat:

1. Select Main Menu > Settings > Installation Settings > Thresholds > Heat Dissipation Time.
2. Configure the settings as required.

Heat Min On Time

Sets the minimum equipment run time in heat mode: 1 to 20 min (default is 5 min).

On Thermostat:

1. Select Main Menu > Settings > Installation Settings > Thresholds > Heat Min On Time.
2. Configure the settings as required.

Cool Differential Temp

The minimum difference between the current temperature and set temperature before the system calls for cool. A smaller

difference means shorter cycle times, whereas a larger difference results in longer cycle times. The temperature range is adjustable from 0 to 3 °F (0 to 1.7 °C) in 0.5°F (0.3°C) increments.

On Thermostat:

1. Select Main Menu > Settings > Installation Settings > Thresholds > Cool Differential Time.
2. Configure the settings as required.

Cool Dissipation Time

The amount of time the fan will run after the cool has been turned off. Running the fan for a period of time allows for any cooled air left in the ducts to circulate throughout the home. The time is adjustable from 0 to 900 seconds. The default value is 30 seconds.

On Thermostat:

1. Select Main Menu > Settings > Installation Settings > Thresholds > Cool Dissipation Time.
2. Configure the settings as required.

Cool Min On Time

Sets the minimum equipment run time in cool mode: 1 to 20 min (default is 5 min).

On Thermostat:

1. Select Main Menu > Settings > Installation Settings > Thresholds > Cool Min On Time.
2. Configure the settings as required.

Compressor Reverse Staging

If enabled, the thermostat will cycle down from the higher stages so that as it approaches set point it will only be running in stage 1. The thermostat calculates which stage to start the HVAC equipment in depending on the indoor and set point temperature delta. . As the stage 1 temperature delta is exceeded, the second stage will engage. Once the equipment has brought the current temperature back to within the heat or

cool differential setting, stage 2 will disengage and stage 1 will remain running until the set point is reached.

On Thermostat:

1. Select Main Menu > Settings > Installation Settings > Thresholds > Compressor Reverse Staging.
2. Configure the settings as required.

Compressor Stage 2 Temp Delta

The minimum difference between the current temperature and the set temperature that will activate the auxiliary heat (regardless if the maximum run time of the previous stage was reached). Options are Auto (default) and 1 to 10 °F (0.6 to 5.6 °C).

On Thermostat:

1. Select Main Menu > Settings > Installation Settings > Thresholds > Compressor Stage 2 Temp Delta.
2. Configure the settings as required.

Compressor Stage 1 Max Runtime

The maximum amount of time stage 1 will run before engaging the next stage. Options are Auto (default) and 10 to 120 minutes.

On Thermostat:

1. Select Main Menu > Settings > Installation Settings > Thresholds > Compressor Stage 1 Max Runtime.
2. Configure the settings as required.

Compressor to Aux Temp Delta

The minimum difference between the current temperature and the set temperature that will activate this stage (regardless if the maximum run time of the previous stage was reached). Options are Auto (default), Disabled, and 1 to 10 °F (0.6 to 5.6 °C).

On Thermostat:

1. Select Main Menu > Settings > Installation Settings > Thresholds > Compressor To Aux Temp Delta.
2. Configure the settings as required.

Compressor to Aux Runtime

The maximum amount of time this stage will run before engaging the next stage. Options are Auto (default) and 1 to 10 °F (0.6 to 5.6 °C).

On Thermostat:

1. Select Main Menu > Settings > Installation Settings > Thresholds > Compressor To Aux Runtime.
2. Configure the settings as required.

Temperature Correction

Lets you program an offset between the real temperature at thermostat and the displayed temperature. If you find that the temperature where the thermostat are located does not represent the room temperature, change the offset to compensate for the difference. The correct temperature is adjustable from +/- 10°F in 0.5°F (0.3°C) increments.

On Thermostat:

1. Select Main Menu > Settings > Installation Settings > Thresholds > Temperature Correction.
2. Swipe left or right to select the value.

Installer Code

To prevent accidental modifications to the installation settings, you can enable a 4-digit installer code. This code is pre-programmed to 3262.

On Thermostat:

1. Select Main Menu > Settings > Installation Settings > Thresholds > Installer Code.
2. Enable or disable the code.

Test Equipment

This menu lets you test the wiring and connections of the devices connected to the thermostat by turning them on or off.

The equipment will turn off when you exit the menu.

Warning: Compressor protection and minimum run-time features are not enforced while in this mode.

Wiring Diagrams

The following pages provide wiring diagrams for common HVAC equipment configurations.

Need help with your ecobee3 wiring? Find how-to videos and tutorials on ecobee.com.

Conventional heating and cooling

Heat Only

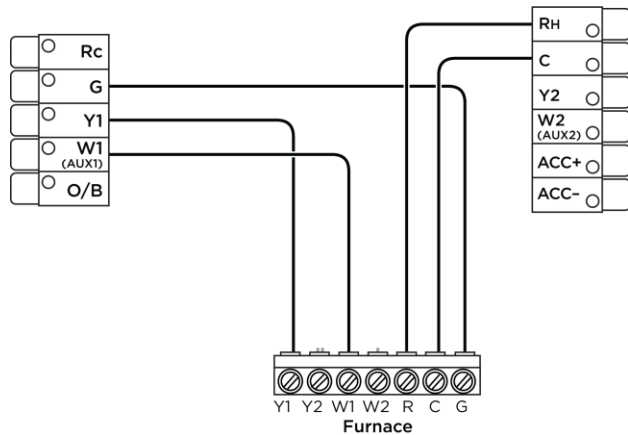

Note: Do not jumper Rc or Rh, ecobee3 does this automatically. R can go into either Rc or Rh terminals on your ecobee3.

Heat and Cool

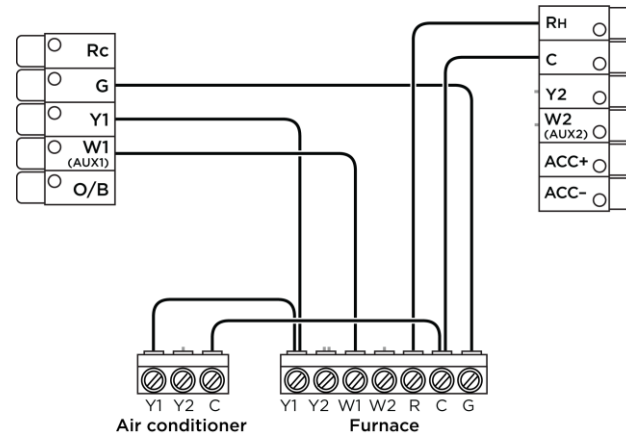

Note: Do not jumper Rc or Rh, ecobee3 does this automatically. R can go into either Rc or Rh terminals on your ecobee3.

Heat and Cool (2 Stage Heat)

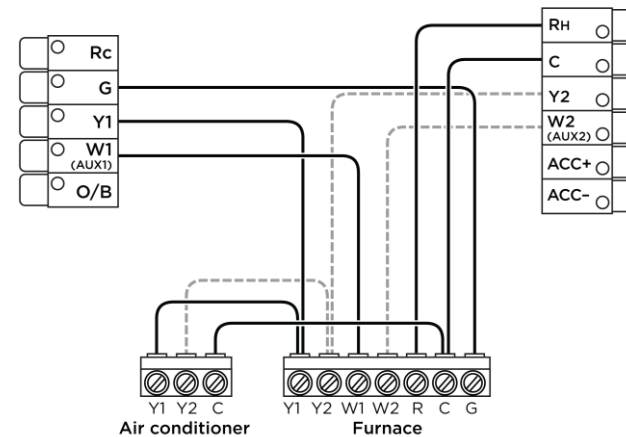

Stage 2 heat and cool

Note: Do not jumper Rc or Rh, ecobee3 does this automatically. R can go into either Rc or Rh terminals on your ecobee3.

Heat pumps

Air or Geothermal Heat Pump with Auxiliary Heat

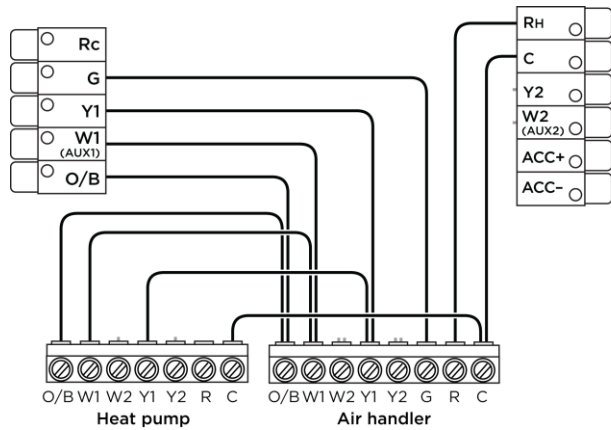

Note: Do not jumper Rc or Rh, ecobee3 does this automatically. R can go into either Rc or Rh terminals on your ecobee3.

Air or Geothermal Heat Pump (2 Stages) with Auxiliary Heat

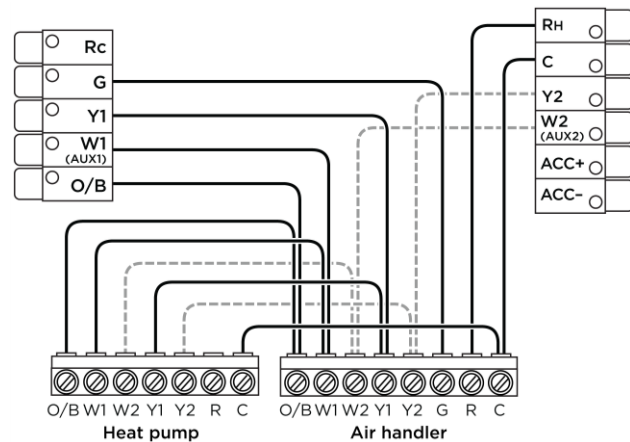

--- Stage 2 compressor and auxiliary heat

Note: Do not jumper Rc or Rh, ecobee3 does this automatically. R can go into either Rc or Rh terminals on your ecobee3.

Boiler or radiant systems

Boiler or Radiant System with Air Handler and Conventional Cooling or Heat Pump

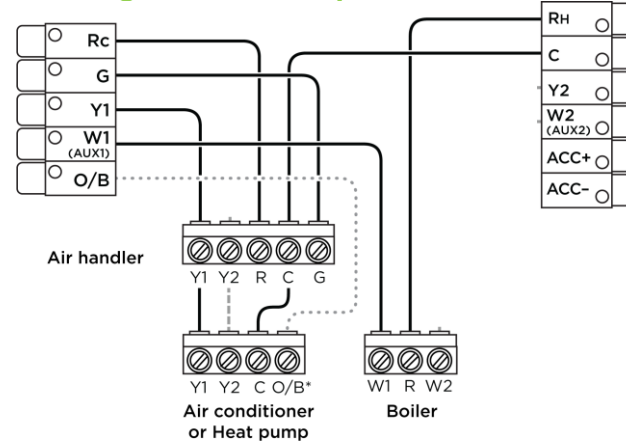

--- *Reversing valve for heat pumps only

Note: Do not jumper Rc or Rh, ecobee3 does this automatically. R can go into either Rc or Rh terminals on your ecobee3.

Boiler or Radiant System (2 stages) with Air Handler and Conventional Cooling or Heat Pump

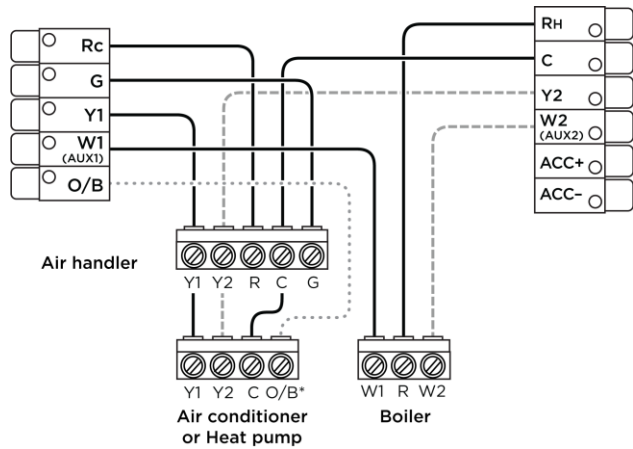

- - Stage 2 heat and cool if applicable
- *Reversing valve for heat pumps only

Note: Do not jumper Rc or Rh, ecobee3 does this automatically. R can go into either Rc or Rh terminals on your ecobee3.

Accessory devices

The ecobee3 can control an accessory HVAC device like a humidifier, dehumidifier, or ventilation device from its ACC terminals.

If the accessory is internally powered, connect the 24V to ACC+. Also connect the common for the accessory to common on the control board.

Hint: If you have 2 wires at the thermostat from the accessory, your accessory is externally powered. If you have only 1 wire then it is internally powered.

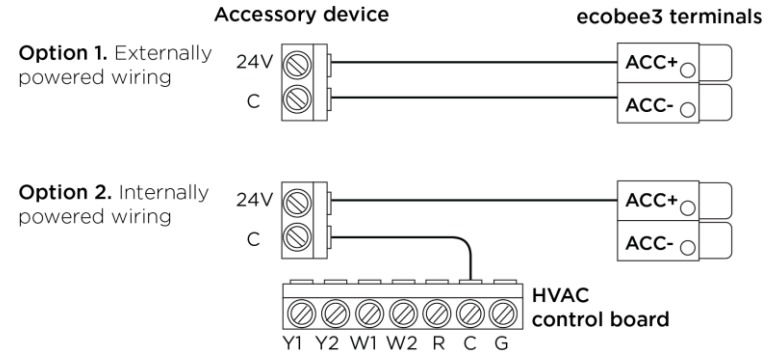

Note: You will need to configure the accessory device when you first power on your ecobee3.

PEK thermostat wiring

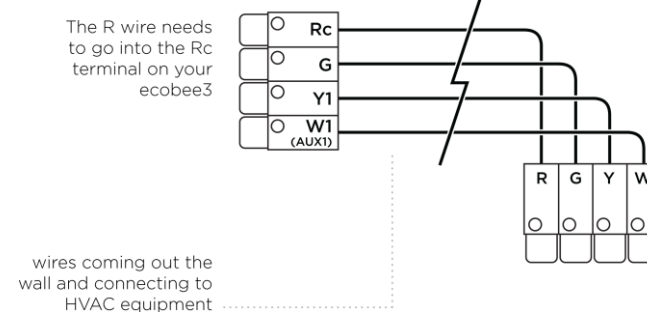

Icon Reference

Note: Depending on your equipment configuration, not all the icons may be available.

Home Screen



Menu



Menu
(with notification)



Weather



Quick Changes

System Operation



System mode:
Heat



System mode:
Cool



System mode:
Auto



Fan

Menus



Registration



System



Reminders
and Alerts



Schedule



Vacation



Settings



Comfort settings



About



Sensors

Comfort Settings



Home



Away



Sleep



Custom 1
(of 5)

Weather



Sunny



Mostly sunny



Clear (night)



Snow (night)



No weather
(N/A)

Wi-Fi Connectivity



Full wi-fi signal



Cannot connect
to wi-fi



Full wi-fi signal
(Connected to
ecobee.com)



Full wi-fi signal
(Cannot connect
to ecobee.com)



Cannot connect
to wi-fi and
ecobee.com

Menu Reference

Note: Depending on your equipment configuration, not all menu options may be available.

Main Menu

Registration

System

HVAC System

Fan

Humidifier

Dehumidifier

Ventilator/HRV/ERV

Sensors

Smart Home/Away

Follow Me

Your Thermostat

Schedule

Comfort Settings

Home

Away

Sleep

Vacation

Reminders & Alerts

Reminders

Alerts

Preferences

HVAC Maintenance

- Air Handler
- Humidifier Filter
- Dehumidifier Filter
- Furnace Filter
- Ventilator Filter
- UV Lamp
- Low Temp Alert
- High Temp Alert
- Aux Heat Runtime Alert
- Aux Outdoor Temp Alert
- Low Humidity Alert
- High Humidity Alert
- Display Alerts on Thermostat
- Enable Heating/Cooling Alerts

Settings

Date & Time

- Time Format
- Date
- Time
- Time Zone

Preferences

- Temperature display
- Heating range
- Cooling range
- Thermostat name
- Screen brightness
- Active to standby
- Hold action
- Heating Smart Recovery
- Cooling Smart Recovery

Wi-Fi

- Wi-Fi Radio
- Network
- Diagnostics

Installation Settings

Equipment

Wiring

Heat Pump

Type

- O/B Reversing Value

- Min Cycle off time

- Min outdoor temp

- Aux Heat Simultaneous Operation

Furnace

- Fan control in Heat mode

Ventilator

- Free Cooling Max Outdoor Temp
- Free Cooling Max Outdoor Humidity
- Indoor/Outdoor Temp Delta
- Max Set Point Temp Delta

Air Conditioner

Dehumidifier

- Dehumidify with fan
- Min Run time delta
- Dehumidify in heat mode
- Dehumidifier Active

Reconfigure equipment

Thresholds

- Auto Heat/Cool
- Heat/Cool Min delta
- Compressor Min Cycle Off Time
- Compressor Min Outdoor Temp
- AC Overcool Max
- Aux Heat Max Outdoor Temp
- Heat Differential Temp
- Heat Dissipation Time
- Heat Min On Time
- Cool Differential Temp
- Cool Dissipation Time
- Cool Min On Time
- Compressor Reverse Staging
- Compressor Stage 2 Temp Delta
- Compress Stage 1 Max Runtime
- Temperature Correction

Installer Code

Test equipment

Access Control

Reset

- Reset Preferences

- Reset All

About

- Support

- Wi-Fi

Weather

Approvals

This product was designed and built in accordance to RoHS directive 2002/95/EC and contains no hazardous substances as defined by this directive.

FCC Compliance Statement

This equipment has been tested and found to comply with the limits for Class B digital devices, pursuant to Part 15 of the FCC Rules. These limits are designed to provide reasonable protection against harmful interference in a residential installation. This equipment generates, uses, and can radiate radio frequency energy and, if not installed and used in accordance with the instruction manual, may cause harmful interference to radio communications. However, there is no guarantee that interference will not occur in a particular installation. If this equipment does cause harmful interference to radio or television reception, which can be determined by turning the equipment off and on, the user is encouraged to try to correct the interference by one or more of the following measures:

- Reorient or relocate the receiving antenna.
- Increase the separation between the equipment and receiver.
- Connect the equipment to an outlet on a different circuit from the receiver.
- Consult the dealer or an experienced radio/TV contractor for help.

To satisfy FCC/IC RF exposure safety requirements, a separation distance of 8 inches (20 cm) or more should be maintained between this device and persons. To ensure compliance, operation at closer than this distance is not allowed.

FCC ID: WR9EBSTATZBE3 IC: 7981A-EBSTATZBE3

Warning: Changes or modifications not expressly approved by ecobee Inc. could void the user's authority to operate the equipment.

3-Year Limited Warranty

ecobee warrants that for a period of three (3) years from the date of purchase by the consumer ("Customer"), the ecobee3 thermostat (the "Product") shall be free of defects in materials and workmanship under normal use and service. During the warranty period, ecobee shall, at its option, repair or replace any defective Products, at no charge. Any replacement and/or repaired device are warranted for the remainder of the original warranty or ninety (90) days, whichever is longer.

If the product is defective, call Customer Service at 1-877-932-6233. ecobee will make the determination whether a replacement product can be sent to you or whether the product should be returned to the following address: ecobee Customer Service, 250 University Ave, Suite 400 Toronto, Ontario M5H 3E5, Canada. In the event of a failure of a Product, Customer may:

(a) if Customer did not purchase the Product directly from ecobee, contact the third party contractor from whom the Product was purchased to obtain an equivalent replacement product, provided the contractor determines that the returned Product is defective and Customer is otherwise eligible to receive a replacement product;

(b) contact ecobee directly for service assistance at 1-877-932-6233 and ecobee will make the determination whether an advance equivalent replacement Product can be sent to Customer with return shipping supplies (in which case a hold shall be put on Customer's credit card for the value of the replacement Product until ecobee has received the defective Product). Product should be returned to the following address: ecobee Customer Service, 250 University Ave, Suite 400 Toronto, Ontario M5H 3E5, Canada. If the returned Product is found by ecobee to be defective and Customer is otherwise eligible to receive a replacement product, no amount shall be charged to Customer's credit card; or

(c) ship the defective Product directly to ecobee, in which case Customer shall contact ecobee directly at 1-877-932-6233, so ecobee can make the required shipping arrangements. Upon receipt of the defective Product, ecobee will ship an equivalent replacement product to Customer, provided the returned Product is found by ecobee to be defective and Customer is otherwise eligible to receive a replacement product.

This warranty does not cover removal or reinstallation costs and shall not apply if the damages were found to be caused by something other than defects in materials or workmanship, including without limitation, if the Product:

- was operated/stored in abnormal use or maintenance conditions; is repaired, modified or altered, unless ecobee expressly
- authorizes such repair, modification or alteration in writing;
- was subject to abuse, neglect, electrical fault, improper handling, accident or acts of nature;
- was not installed by a licensed Heating Ventilating and Air Conditioning (HVAC) contractor; or
- was installed improperly.

ecobee's sole responsibility shall be to repair or replace the Product within the terms stated above. ECOBEE SHALL NOT BE LIABLE FOR ANY LOSS OR DAMAGE OF ANY KIND, INCLUDING ANY SPECIAL, INCIDENTAL OR CONSEQUENTIAL DAMAGES RESULTING, DIRECTLY OR INDIRECTLY, FROM ANY BREACH OF ANY WARRANTY, EXPRESS OR IMPLIED, OR ANY OTHER FAILURE OF THIS PRODUCT. Some US states and Canadian provinces do not allow the exclusion or limitation of incidental or consequential damages, so the above limitation or exclusion may not apply to you.

ecobee's responsibility for malfunctions and defects in materials and workmanship is limited to repair and replacement as set forth in this warranty statement. All express and implied warranties for the product, including but not limited to any implied warranties and conditions of merchantability and fitness

for a particular purpose, are limited to the three-year duration of this limited warranty. No warranties, whether express or implied, will apply after the limited warranty period has expired. Some

US states and Canadian provinces do not allow limitations on how long an implied warranty lasts, so this limitation may not apply.

ecobee neither assumes responsibility for nor authorizes any other person purporting to act on its behalf to modify or to change this warranty, nor to assume for it any other warranty or liability concerning this product.

This warranty gives you specific rights, and you may also have other rights which vary from jurisdiction to jurisdiction. If you have any questions regarding this warranty, please write ecobee Customer Service, 250 University Ave, Suite 400 Toronto, Ontario M5H 3E5, Canada.

End User Software License Agreement

Please read the following carefully, as this end user software license agreement ("EULA") is a legal agreement between ecobee Inc., having its place of business at 250 University Ave, Suite 400 Toronto, Ontario M5H 3E5, Canada, ("ecobee") and you (either an individual or the entity that you represent and referred to in this agreement as "licensee"), The original purchaser of ecobee product (The "product" or "products") embedded with ecobee proprietary software (the "software") concerning licensee's limited access to and use of the software. By using the product (including the software embedded in the product), you are indicating your acceptance of, and you agree to be bound by the terms and conditions of this EULA which shall govern your access and use of the software. If you do not agree with the terms and conditions of this EULA, your access to and use of the software will not be permitted and you

may, within fourteen days of the date of your purchase if the ecobee product, return the software together with the product in its original packaging and sale condition to: (a) ecobee if you have purchased the ecobee product directly from ecobee or; (b) to an ecobee authorized reseller or distributor if you have purchased the ecobee product from such entities, and ecobee or its authorized reseller or distributor as applicable shall provide a full refund of the purchase price paid within fourteen days of its receipt of the return.

In consideration of the license fees paid by LICENSEE as part of the purchase price of the ecobee Product and the mutual covenants contained herein and for other good and valuable consideration, the receipt and sufficiency of which are hereby acknowledged, ecobee and LICENSEE agree as follows:

1. Definitions: For the purpose of this EULA, the following terms shall have the meanings hereinafter provided:

"ecobee Web Portal" means the web site portal operated by ecobee to provide certain services and functionality to registered users of ecobee Products.

"Error" means any program defect, error, bug or other failure of all or part of the Software that results in the Software not conforming to, or performing in accordance with, its published specifications.

"Software" means ecobee's computer software program, which enables data upload and download to and from the ecobee Web Portal using an ecobee Product, including any Software Updates.

"User Manual" means the ecobee User Manual provided together with the Product and Software.

"Software Updates" means updates or patches to the Software, including updates intended to correct Errors and which may include enhancements and/or additional features to the Software, as may be provided or released by ecobee from time to time to all of its customers at no charge.

2. Ownership of Software: LICENSEE acknowledges and agrees that, save and except for the Software license explicitly granted by the EULA, all right, title and interest

in and to the Software and the User Manual is the sole and exclusive property of ecobee and/or its licensors), as the case may be. ecobee reserves all rights not expressly granted to LICENSEE hereunder, and for greater certainty, ecobee shall retain all intellectual property and other proprietary rights in and to the Software and the User Manual. Nothing in this EULA shall, or shall be deemed or construed to, assign, transfer or convey to LICENSEE any title, rights or interest in or to any intellectual property, including in or to the Software or User Manual, other than the licenses specifically and expressly granted herein.

3. Grant of Limited License: Upon LICENSEE's use of the Product (and corresponding acceptance of the terms and conditions of this EULA), ecobee hereby grants to LICENSEE a limited, non-exclusive, personal, perpetual, non-transferable and revocable license to use the Software embedded in the Product as and to the extent described in this EULA for as long as LICENSEE complies with the terms and condition of this EULA. ecobee reserves all rights not expressly granted to LICENSEE. For certainty, this EULA does not apply to or govern LICENSEE's use of or access to the ecobee Web Portal or the ecobee Product, which are each governed by and subject to separate terms and conditions.

4. Permitted Use: Pursuant to the Software license granted to LICENSEE under this EULA, LICENSEE shall be permitted to: (a) use the Software embedded in the Product for

the purposes of using the Product only as intended and contemplated by the User Manual, provided that the Software may only be used for its personal and private use in connection with the use of the Product; and (b) use the User Manual provided by ecobee solely as is necessary to operate and use the Software and ecobee Product as and to the extent permitted thereunder and under this EULA.

5. License Transferable: This EULA shall be binding upon and shall ensure to the benefit of and be enforceable by each of the parties, their respective successors and permitted assigns. LICENSEE may assign this EULA without the prior consent of ecobee. ecobee may assign this EULA without the consent of LICENSEE at any time.

6. Copy Restrictions: Unauthorized copying or distribution of Software or the User Manual is expressly prohibited. LICENSEE may make a reasonable number of copies of the User Manual to the extent reasonably required for its use of the Software and Product as permitted by this EULA; provided that LICENSEE may not use the User Manual separately from the Product or Software or for any purpose other than as contemplated herein.

7. Use Restrictions: LICENSEE may not: (a) modify, adapt or otherwise change the Software or in any way remove the Software from the Product for any reason or

use the Software separately from the Product for any reason or purpose; (b) to the maximum extent permitted to be restricted by applicable law, reverse engineer, decompile, disassemble, or otherwise in any manner deconstruct all or any part of the Software; (c) create derivative works based on the Software or the User Manual; (d) except as expressly permitted by the EULA, provide, disclose, sublicense, distribute, transfer, assign or otherwise permit any third party to access, use, read or otherwise gain access to the Software or User Manual (the Software and User Manual being the confidential information of ecobee); or (e) use Software to access or in conjunction with any other thermostat monitoring services or products of any ecobee competitor.

8. Support: ecobee may in its discretion, without any obligation to do so and subject to the limitations of this EULA, provide LICENSEE with help-desk telephone support concerning LICENSEE's use of the SOFTWARE to the extent provided for in the Product Terms of Sale in connection with purchase and sale of the Product and the Terms of Service entered into by you and ecobee, if any, in connection with the thermostat monitoring and data management services provided by

ecobee in connection with the Product. Refer to the Product Terms of Sale and/or the Terms of Service associated with the Product and related services for further details on Software and Product support.

9. Relief: LICENSEE agrees that damages would not be an adequate remedy for any breach of this EULA affecting or related to a breach or misappropriation of ecobee's (or its or its third party licensors') intellectual property rights in and to the Software and User Manual. LICENSEE, and nothing in this EULA, shall interfere with, delay, obstruct, or prevent ecobee from taking, or require ecobee to take, any steps prior to taking action to seek an interim and interlocutory equitable remedy on notice or ex parte to enforce any provision herein to protect its rights concerning the Software or other intellectual or proprietary rights. LICENSEE agrees not to contest, object to, or otherwise oppose an application for equitable relief by ecobee in such circumstances and LICENSEE waives any and all immunities from any equitable relief to which it may be entitled. Any such relief or remedy shall not be exclusive, but shall be in addition to all other available legal or equitable remedies. LICENSEE agrees that the provisions of this Section are fair and reasonable and are necessary to protect ecobee's intellectual property rights.

10. Termination: This EULA is effective until and unless terminated. Subject to Section 13, this EULA will terminate automatically if LICENSEE fails to comply with any provision of the License. If LICENSEE is a business entity or other entity, any failure to comply with the terms and condition of this EULA by any individual employed or engaged by such entity will be deemed a failure to comply by LICENSEE. Upon any termination, LICENSEE shall destroy all copies of Software and User Manual.

11. Warranty: (a) ecobee shall provide its standard Product and Software limited warranty statement ("Customer Warranty"), which equally applies to the Software embedded in the Product, and which is incorporated by reference herein, with the Product for your benefit only. In the event of an Error in

connection with the Software, refer to the Customer Warranty and Terms

of Sale provided with the Product for further detail. (b) EXCEPT FOR THE REPRESENTATIONS, WARRANTIES, AND COVENANTS EXPRESSLY CONTAINED

IN THIS EULA, THE PRODUCT TERMS OF SALE AND THE PRODUCT WARRANTY, THE SOFTWARE AND SOFTWARE DOCUMENTATION AND ANY SUPPORT IS PROVIDED ON AN "AS IS" BASIS, AND THERE ARE NO OTHER REPRESENTATIONS, WARRANTIES, COVENANTS, OR CONDITIONS, EXPRESS OR IMPLIED (INCLUDING ANY IMPLIED WARRANTIES OR CONDITIONS OF MERCHANTABILITY OR FITNESS FOR A PARTICULAR PURPOSE AND THOSE ARISING BY STATUTE OR OTHERWISE IN LAW OR FROM A COURSE OF DEALING OR USAGE OF TRADE), INCLUDING, BUT NOT LIMITED TO, NON-INFRINGEMENT, CORRECTNESS, FUNCTIONALITY, RELIABILITY, ACCURACY, CURRENTNESS, OPERATION, USE

OR THE RESULTS OF THE USE BY LICENSEE, THAT THE OPERATION OF THE SOFTWARE WILL BE UNINTERRUPTED OR ERROR-FREE (OR THAT ALL ERRORS CAN OR WILL BE CORRECTED) OR THAT THE SOFTWARE OR SOFTWARE DOCUMENTATION WILL MEET LICENSEE'S REQUIREMENTS, ALL OF WHICH ARE EXPRESSLY DENIED AND DISCLAIMED TO THE MAXIMUM EXTENT PERMITTED BY LAW. SOME JURISDICTIONS DO NOT PERMIT LIMITATIONS ON OR EXCLUSIONS OF CERTAIN IMPLIED WARRANTIES, OR THE EXCLUSION OR LIMITATION OF CERTAIN

DAMAGES; THEREFORE THE ABOVE LIMITATIONS MAY NOT APPLY TO YOU IN CERTAIN CIRCUMSTANCES. ecobee DISCLAIMS AND SHALL HAVE NO LIABILITY TO LICENSEE FOR ANY AND ALL ACTS OF THIRD PARTIES. NO OTHER PERSON IS AUTHORIZED TO EXTEND, VARY OR TRANSFER ANY PROVIDED WARRANTY ON BEHALF OF ecobee. THE ENTIRE RISK AS TO THE RESULTS AND PERFORMANCE AND USE OF THE SOFTWARE, SOFTWARE DOCUMENTATION AND ANY PROVIDED SUPPORT IS ASSUMED BY LICENSEE.

12. Limitation: IN NO EVENT AND TO THE MAXIMUM EXTENT PERMITTED UNDER APPLICABLE LAW SHALL ECOBEE, ITS SHAREHOLDERS, AFFILIATES, CONTRACTORS, SUPPLIERS AND AGENTS

AND THEIR RESPECTIVE DIRECTORS, OFFICERS AND EMPLOYEES (COLLECTIVELY THE "ECOBEE PARTIES") BE LIABLE TO LICENSEE OR ANY THIRD PARTY FOR ANY INDIRECT, INCIDENTAL, EXEMPLARY, SPECIAL, PUNITIVE OR CONSEQUENTIAL DAMAGES (INCLUDING WITH RESPECT TO LOSS OF, OR DAMAGE TO, DATA OR COMPUTER SYSTEMS OR RELIANCE ON ANY DATA DERIVED FROM LICENSEE'S USE OF THE SOFTWARE, OR LOSS OF REVENUE OR PROFIT OR OTHER ECONOMIC LOSS) OF ANY KIND OR NATURE WHATSOEVER SUFFERED BY LICENSEE OR ANY THIRD PARTY HOWSOEVER CAUSED AND WHETHER RESULTING FROM THE USE OF OR INABILITY TO USE THE SOFTWARE OR OTHERWISE (INCLUDING

AS A RESULT OF OR DUE TO USE OF OR RELIANCE ON THE SOFTWARE AND/OR ecobee WEB PORTAL) AND REGARDLESS OF THE FORM OR CAUSE OF ACTION, EVEN IF SUCH DAMAGES ARE FORESEEABLE OR ecobee HAS BEEN ADVISED OF THE POSSIBILITY OF SUCH DAMAGES. ECOBEE PARTIES' TOTAL LIABILITY

AND OBLIGATION TO LICENSEE, IN THE AGGREGATE FOR ANY AND ALL CLAIMS ARISING OUT OF OR IN ANY CONNECTION WITH THIS EULA, THE TERMS OF SALE IN CONNECTION WITH YOUR PURCHASE OF THE PRODUCT AND YOUR USE OF

THE SOFTWARE AND PRODUCT, WITH RESPECT TO ANY EXPENSE, DAMAGE, LOSS, INJURY, OR LIABILITY OF ANY KIND, REGARDLESS OF THE FORM OF ACTION OR THEORY OF LIABILITY (INCLUDING FOR BREACH OF CONTRACT, TORT, NEGLIGENCE, BY STATUTE OR OTHERWISE) SHALL BE LIMITED TO THE ACTUAL DIRECT DAMAGES SUFFERED AND SHALL NOT EXCEED AN AMOUNT THAT IS EQUIVALENT TO THE PURCHASE PRICE OF THE ecobee PRODUCT ACTUALLY PAID BY LICENSEE. THIS SECTION SHALL SURVIVE A FUNDAMENTAL BREACH OR BREACHES AND/OR FAILURE OF THE ESSENTIAL PURPOSE OF THE AGREEMENT.

13. Survival: The parties acknowledge and agree that the provisions of Sections 2, 6, 7, 9, 11(b), 12, 13, 14, 15, 16 and 17 shall survive any termination of this EULA for any reason.

14. English Language: The parties declare that they have required that this agreement and all documents related hereto,

either present or future, be drawn up in the English language only. Les parties déclarent par les présentes qu'elles exigent que cette entente et tous les documents y afférents, soit pour le présent ou le futur, soient rédigés en langue anglaise seulement.

15. Jurisdiction: This EULA shall be exclusively governed by, construed and interpreted in accordance with the laws of the Province of Ontario, Canada. For the purpose of all legal proceedings this EULA shall be deemed to have been performed in the Province of Ontario, Canada and the parties expressly confirm that the law of the Province of Ontario is the proper law. If Customer is located in a jurisdiction other than Canada, the parties agree that neither the United Nations Convention of the International Sale of Goods or the (U.S.) Uniform Computer Information Transactions Act shall apply to this EULA. The parties irrevocably attorn to the non-exclusive jurisdiction of the Courts of the Province of Ontario in respect of all matters and disputes arising hereunder.

16. Export Law Assurances: LICENSEE acknowledges that the Software may be subject to export and import control laws, and agrees to comply fully with those laws in connection with the Software.

17. General Provisions: No delay or omission by ecobee to exercise any right or power it has under this EULA or to object to the failure of any covenant of LICENSEE to be performed in a timely and complete manner, shall impair any such right or power or be construed as a waiver of any succeeding breach or any other covenant. Any waivers by ecobee must be in writing and signed by an authorized representative of ecobee. If any provision of this EULA is held by a court of competent jurisdiction to be invalid or unenforceable in any respect, then the remaining provisions of this EULA, or the application of

such provisions to persons or circumstances other than those as to which it is invalid or unenforceable shall not be affected thereby, and each such provision of this EULA shall be valid and enforceable to the extent granted by law. The EULA constitutes the entire agreement between the parties as it relates to the

license and use of the Software and User Manual and the subject matter of this EULA and supersedes all prior or contemporaneous agreements, negotiations, representations and proposals, written or oral between ecobee and LICENSEE. The EULA may only be amended or supplemented by written agreement executed by each of the parties.