

AIRSTAGE

FUJITSU

INVERTER

AIR CONDITIONER

Floor Type

OPERATION MANUAL

MODE D'EMPLOI

MANUAL DE FUNCIONAMIENTO

English

Français

Español

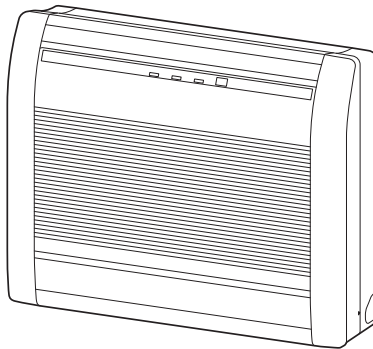

KEEP THIS OPERATING MANUAL
FOR FUTURE REFERENCE

CONSERVEZ CE MODE D'EMPLOI AFIN DE
POUVOIR VOUS Y RÉFÉRER ULTÉRIEUREMENT

GUARDE ESTE MANUAL DE USO PARA
FUTURAS CONSULTAS

FUJITSU GENERAL LIMITED



PART NO. 9378532076-02

CONTENTS

PART NO. 9378532076-02

SAFETY PRECAUTIONS.....	En-2	MIN. (MINIMUM) HEAT OPERATION	En-12
FEATURES AND FUNCTIONS	En-3	ECONOMY OPERATION	En-12
NAME OF PARTS	En-4	SWING OPERATION	En-13
PREPARATION	En-6	MANUAL AUTO OPERATION	En-13
OPERATION.....	En-7	POWERFUL OPERATION	En-13
TIMER OPERATION	En-8	CLEANING AND CARE	En-14
ADJUSTING THE DIRECTION OF AIR		TROUBLESHOOTING	En-16
CIRCULATION	En-10	OPERATING TIPS.....	En-18
AIR OUTLET SELECTION	En-11		

SAFETY PRECAUTIONS

To prevent personal injury, injury to others, or property damage, read this section carefully before you use this product, and be sure to comply to the following safety precautions.

Incorrect operation due to failure to follow the instructions may cause harm or damage, the seriousness of which is classified as follows:



WARNING





This mark warns of death or serious injury.



CAUTION

This mark warns of injury or damage to property.

- Explanation of symbols displayed on the indoor unit or outdoor unit.

	WARNING	This symbol shows that this appliance uses a flammable refrigerant. If the refrigerant is leaked and exposure to an external ignition source, there is a risk of fire.
	CAUTION	This symbol shows that the Operation Manual should be read carefully.
	CAUTION	This symbol shows that a service personnel should be handling this equipment with reference to the Installation Manual.
	CAUTION	This symbol shows that information is available such as the Operating Manual or Installation Manual.



WARNING

- Do not attempt to install this air conditioner by yourself.
- This unit contains no user-serviceable parts. Always consult authorized service personnel for repairs.
- When moving, consult authorized service personnel for disconnection and installation of the unit.
- Do not become excessively chilled by staying for lengthy periods in the direct cooling airflow.
- Do not insert anything into the Airflow direction.
- Do not start and stop air conditioner operation by disconnecting the power supply cord.
- Take care not to damage the power supply cord.
- If the power supply cord of this appliance is damaged, it should only be replaced by the authorized service personal, since special purpose tools and specified cord are required.
- In the event of a malfunction (burning smell, etc.), immediately stop operation, turn off the breaker, and consult authorized service personnel.
- In the event of refrigerant leakage, be sure to keep away from fire or any flammables. (consult an authorized service personnel)



CAUTION

- Provide occasional ventilation during use.
- Do not direct airflow at fireplaces or heating apparatus.
- Do not climb on, or place objects on, the air conditioner.
- Do not hang objects from the indoor unit.
- Do not set flower vases or water containers on top of air conditioners.
- Do not place any other electrical products or household belongings under indoor unit or outdoor unit. Dripping condensation from the unit might get them wet, and may cause damage or malfunction of your property.
- Do not expose the air conditioner directly to water.
- Do not operate the air conditioner with wet hands.
- Do not pull power supply cord.
- Turn off power source when not using the unit for extended periods.
- Check the condition of the installation stand for damage.
- Do not place animals or plants in the direct path of the airflow.
- Do not drink the water drained from the air conditioner.
- Do not use in applications involving the storage of foods, plants or animals, precision equipment, or art works.
- Do not touch the aluminum fins of heat exchanger built-in the indoor or outdoor unit to avoid personal injury when you install or maintain the unit.
- Connection valves become hot during Heating; handle with care.
- Do not apply any heavy pressure to radiator fins.
- Operate only with air filters installed.
- Do not block or cover the intake grille and outlet port.
- Ensure that any electronic equipment is at least 40 in. (1 m) away from either the indoor or outdoor units.
- Avoid installing the air conditioner near a fireplace or other heating apparatus.
- When installing the indoor and outdoor unit, take precautions to prevent access to infants.
- Do not use inflammable gases near the air conditioner.
- Do not sit and place anything on the unit.
- This appliance is not intended for use by persons (including children) with reduced physical, sensory or mental capabilities, or lack of experience and knowledge, unless they have been given supervision or instruction concerning use of the appliance by a person responsible for their safety. Children should be supervised to ensure that they do not play with the appliance.

FEATURES AND FUNCTIONS

INVERTER

At the start of operation, large amount of power is used to bring the room quickly to the desired temperature. Afterwards, the unit automatically switches to a low power setting for economic and comfortable operation.

AUTO CHANGEOVER

The operation mode (cooling, dry, heating) is switched automatically to maintain the set temperature, and the temperature is kept constant at all times.

MIN. (MINIMUM) HEAT OPERATION

The room temperature can be maintained at 50°F (10°C) so as to prevent the room temperature from falling too far.

ECONOMY OPERATION

When economy operation mode is operated, the room temperature will be little higher than the set-temp under cooling mode and lower than set-temp under heating mode. Therefore, the economy mode is able to save more energy than other normal mode.

PROGRAM TIMER

The program timer allows you to integrate OFF timer and ON timer operations in a single sequence. The sequence can involve 1 transition from OFF timer to ON timer, or from ON timer to OFF timer, within a 24 hour period.

SLEEP TIMER

When the SLEEP button is pressed during Heating mode, the air conditioner's temperature setting is gradually lowered during the period of operation; during cooling mode, the temperature setting is gradually raised during the period of operation. When the set time is reached, the unit automatically turns off.

WIRELESS REMOTE CONTROLLER

The Wireless Remote Controller allows convenient control of air conditioner operation.

SWING OPERATION

The Airflow Direction Louvers swings automatically up and down so that the air speeds to every nook and corner of your room.

REMOVABLE OPEN PANEL

The indoor unit's Open Panel can be removed for easy cleaning and maintenance.

MILDEW-RESISTANT FILTER

The AIR FILTER has been treated to resist mildew growth, thus allowing cleaner use and easier care.

SUPER QUIET OPERATION

When the FAN button is used to select QUIET, the unit begins super-quiet operation; the indoor unit's airflow is reduced to produce quieter operation.

POLYPHENOL CATECHIN AIR CLEANING FILTER

The polyphenol catechin air cleaning filter uses static electricity to clean the air of fine particles and dust such as tobacco smoke and plant pollen that are too small to see.

The filter contains catechin, which is highly effective against various bacteria by suppressing the growth of the bacteria adsorbed by the filter.

Note that when the air cleaning filter is installed, the amount of air produced decreases, causing a slight decrease in the air conditioner's performance.

NEGATIVE AIR IONS DEODORIZING FILTER

It comprises pottery super micro particles, which can produce negative air ions having the effect of deodorizing and can absorb and remit the peculiar smell at home.

WIRED REMOTE CONTROLLER (OPTION)

The optional wired remote controller can be used.

When you use remote controller, there are following different points as compared with using wireless remote controller.

[The additional functions for wired ones]

- Weekly timer
- Temperature set back timer

And you can use both wired and wireless remote controller simultaneously.

(But function is limited)

When the restricted functions on the remote controller are used, beeping sound will be heard, OPERATION, TIMER and the 3rd lamp of the indoor unit will flash.

[The restricted functions for wireless ones]

- SLEEP TIMER
- TIMER
- MIN. HEAT
- POWERFUL OPERATION

POWERFUL OPERATION

The product will operate at maximum power, which is convenient when you want to quickly cool down or warm up the room.

NAME OF PARTS

Fig. 1

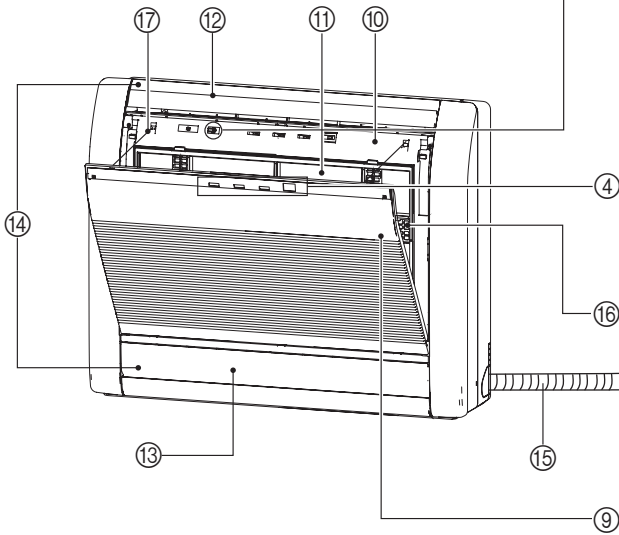

Fig. 2



Fig. 3

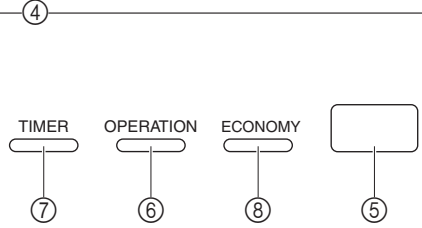

Fig. 4

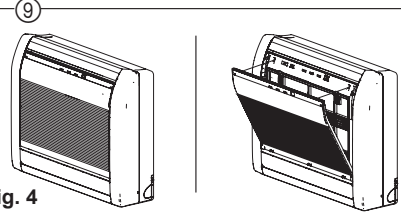

Fig. 5

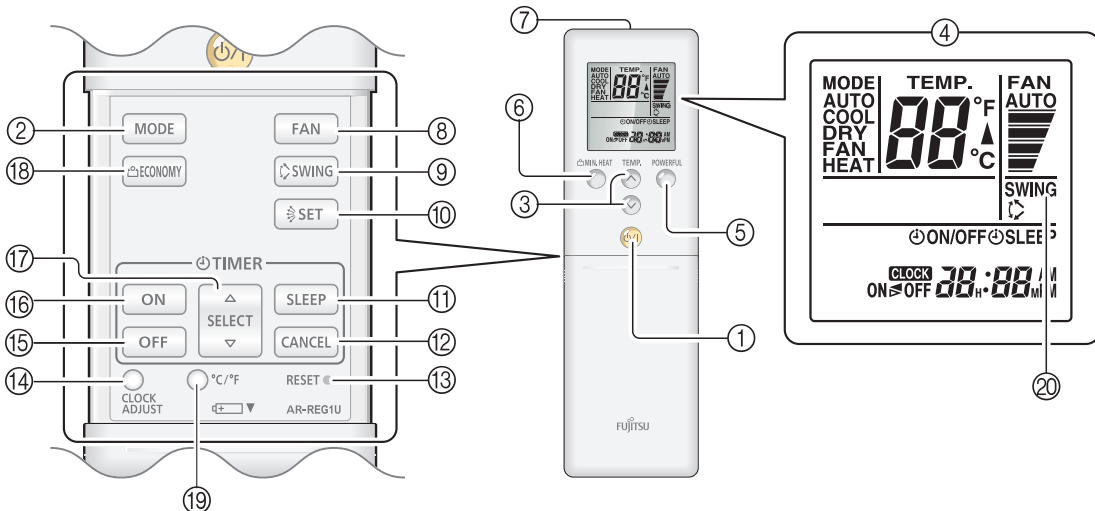

Fig. 1 Indoor Unit

- ① **Operating Control Panel (Fig. 2)**
- ② **Air Outlet Selection switch**
- ③ **MANUAL AUTO button**
 - When the MANUAL AUTO button is pressed in for more than 10 seconds, the forced cooling operation will start.
 - The forced cooling operation is used at the time of installation.
Only for authorized service personnel's use.
 - When the forced cooling operation starts by any chance, press the START/STOP button to stop the operation.
- ④ **Indicator (Fig. 3)**
- ⑤ **Remote Control Signal Receiver**
- ⑥ **OPERATION Indicator Lamp (green)**
- ⑦ **TIMER Indicator Lamp (orange)**
 - If the TIMER indicator lamp flashes when the timer is operating, it indicates that a fault has occurred with the timer setting (See Page 16 Auto Restart).
- ⑧ **ECONOMY Indicator Lamp (green)**
- ⑨ **Intake Grille (Fig. 4)**
- ⑩ **Front Panel**
- ⑪ **Air Filter**
- ⑫ **Airflow Direction Louver**
- ⑬ **Damper**
- ⑭ **Right-Left Louver
(behind Airflow Direction Louver and Damper)**
- ⑮ **Drain Hose**
- ⑯ **Air Cleaning Filter**
- ⑰ **Rope**

Fig. 5 Remote Controller

- ① **START/STOP button**
- ② **MODE button**
- ③ **SET TEMP. (temperature) buttons**
- ④ **Remote controller display**
- ⑤ **POWERFUL button**
- ⑥ **MIN. HEAT button**
- ⑦ **Signal transmitter**
- ⑧ **FAN button**
- ⑨ **SWING button**
- ⑩ **SET button**
- ⑪ **SLEEP timer button**
- ⑫ **CANCEL button**
- ⑬ **RESET button**
 - When you press the RESET button, press it gently by using the tip of a ballpoint pen or other small object in correct direction as shown in this figure.
- ⑭ **CLOCK ADJUST button**
- ⑮ **OFF timer button**
- ⑯ **ON timer button**
- ⑰ **SELECT button**
- ⑱ **ECONOMY button**
- ⑲ **°C / °F button**
- ⑳ **SWING display**



PREPARATION

⚠ CAUTION

- To prevent malfunction or damage of the remote controller:
 - Place remote controller at where will not be exposed to direct sunlight or excessive heat.
 - Remove batteries if the product is not going to be used for an extended period.
 - Exhausted batteries must be removed immediately, and be disposed according to the local laws and regulations of your region.
- If leaking battery fluid comes in contact with your skin, eyes, or mouth, immediately rinse with plenty of clean water, and consult your physician.
- Obstacles such as a curtain or wall between the remote controller and the indoor unit may affect the appropriate signal transmission.
- Do not apply strong shocks to the remote controller.
- Do not pour water on the remote controller.
- Do not attempt to recharge dry batteries.

Inserting batteries (R03/LR03/AAA × 2)

- 1 Turn the remote controller over and push the back side of the cover and remove the claws by curving the cover.
- 2 Pull in the direction of the arrow while curving the cover.
- 3
- 4 Press "RESET" as shown in the figure above. Use the tip of a ballpoint pen or other small object.
- 5 Press "CLOCK ADJUST" to start clock setting.
- 6 Press "SELECT (△▽)" to set the clock. Press the buttons to change the clock by a minute. Press and hold the buttons to change the clock by 10 minutes. * To switch the time indicator (12-hour ⇄ 24-hour), press "TEMP. (∧∨)".
- 7 Press "CLOCK ADJUST" to complete the setting.
- 8 Install and close the cover.

NOTES:

- Use specified type of batteries only.
- Do not mix different types or new and used batteries together.
- Batteries can be used about 1 year in ordinary use.
- If the remote control range noticeably shortens, replace the batteries, and press "RESET" as shown in the figure above.

Remote Controller Holder

⚠ CAUTION

- If there is a curtain or a wall between the remote control and the receptor, the signal will not reach it.
- When the receptor receives strong light, the air-conditioner may not operate correctly. Avoid direct exposure to sunlight, and keep the signal-receiving part away from lights and flat panel television screens. The signal may not be received in rooms with instantaneous fluorescent lights (such as inverter type ones). In such cases, please consult at the store where you purchased the product.
- Please place the remote control in a place which will not be affected by heat from direct sunlight and home heaters.
- Please do not apply strong shocks to the remote controller or pour water on it.

- 1 **Mount the Holder.** Screws
- 2 **Set the Remote Controller.** Insert
Press in
- 3 **To remove the Remote Controller (when use at hand).** Slide up
Pull out

Remote controller custom code setting

Use the following steps to select the custom code of the remote controller.

(Note that the air conditioner cannot receive a custom code if the air conditioner has not been set for the custom code.)

1. Press the START/STOP button until only the clock is displayed on the remote controller display.
2. Press the MODE button for at least five seconds to display the current custom code (initially set to **A**).
3. Press the SET TEMP. (∧ / ∨) button to change the custom code between **A** → **b** → **c** → **d**. Match the code on the display to the air conditioner custom code.
4. Press the MODE button again to return to the clock display. The custom code will be changed.

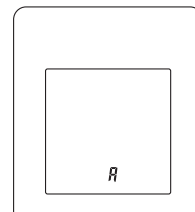

If no buttons are pressed within 30 seconds after the custom code is displayed, the system returns to the original clock display. In this case, start again from step 1.

The air conditioner custom code is set to A prior to shipment. Contact your retailer to change the custom code.

The remote controller resets to custom code A when the batteries in the remote controller are replaced. If you use a custom code other than custom code A, reset the custom code after replacing the batteries. If you do not know the air conditioner custom code setting, try each of the custom codes (**A** → **b** → **c** → **d**) until you find the code which operates the air conditioner.

OPERATION

You can quickly start the operation with following 3 steps:

To Select Mode Operation

- 1 Press the **START/STOP** button (Fig.5 ①).
- 2 Press the **MODE** button (Fig.5 ②) to select the desired mode.

Switches operation mode in following order.



Notes in HEAT mode:

- At the beginning of the operation, the indoor unit operates at very low fan speed for about 3–5 minutes for preparation, and then switches to the selected fan speed.
- Automatic defrosting operation overrides the heating operation when it is necessary.

To Set the Temperature

Press the **SET TEMP.** button (Fig. 5 ③).

- ▲ **button**: Press to raise the temperature setting.
- ▼ **button**: Press to lower the temperature setting.

Set desired temperature.

In COOL/DRY mode, the value needs to be set at lower temperature than current room temperature, and in HEAT mode, the value needs to be set at higher temperature than current room temperature. Otherwise, corresponding operation mode does not start to work.

Temperature setting range	
AUTO/COOL/DRY	64-88 °F (18-30 °C)
HEAT	60-88 °F (16-30 °C)

*:Temperature control is not available in FAN mode.

To Set the Fan Speed

Press the **FAN** button (Fig. 5 ⑧).

Each time the button is pressed, the fan speed changes in the following order:

Controls the fan speed.

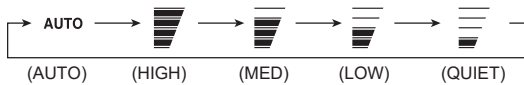

- When AUTO is selected, the fan speed is automatically adjusted according to the operation mode.

SUPER QUIET Operation

SUPER QUIET operation begins. The indoor unit's airflow will be reduced for quieter operation.

- SUPER QUIET operation cannot be used during Dry mode. (The same is true when dry mode is selected during AUTO mode operation.)
- During Super Quiet operation, Heating and Cooling performance will be reduced somewhat. If the room does not warm up/ cool down when using SUPER QUIET Operation, please adjust the air conditioner's Fan Speed.

OPERATION

To Stop Operation

Press the **START/STOP** button (Fig. 5 ①).

The OPERATION Indicator Lamp (green) (Fig. 3 ⑥) will go out.

About AUTO CHANGEOVER Operation

AUTO:

- When AUTO CHANGEOVER operation first selected, the fan will operate at very low speed for about a few minutes, during which time the indoor unit detects the room conditions and selects the proper operation mode.

If the difference between temperature setting and actual room temperature is more than +4 °F (+2 °C) → Cooling or dry operation

If the difference between temperature setting and actual room temperature is within ±4 °F (±2 °C) → Determined by outdoor temperature

If the difference between temperature setting and actual room temperature is more than -4 °F (-2 °C) → Heating operation

- When the indoor unit has adjusted your room's temperature to near the temperature setting, it will begin monitor operation. In the monitor operation mode, the fan will operate at low speed. If the room temperature subsequently changes, the indoor unit will once again select the appropriate operation (Heating, Cooling) to adjust the temperature to the value set in the temperature.
- If the mode automatically selected by the indoor unit is not what you wish, select one of the mode operation (HEAT, COOL, DRY, FAN).

About Mode Operation

Heating: ● Use to warm your room.

- When Heating mode is selected, the indoor unit will operate at very low fan speed for about 3 to 5 minutes, after which it will switch to the selected fan setting. This period of time is provided to allow the indoor unit to warm up before begin full operation.
- When the outdoor temperature is very low, frost may form on the outdoor unit, and its performance may be reduced. In order to remove such frost, the air conditioner will automatically enter the defrost cycle from time to time. During Automatic Defrosting operation, the OPERATION Indicator Lamp will flash, and the Heat operation will be interrupted.
- After the start of Heating operation, it takes some time before the room gets warmer.

Cooling: ● Use to cool your room.

Dry: ● Use for gently cooling while dehumidifying your room.

- You cannot heat the room during Dry mode.
- During Dry mode, the indoor unit will operate at low speed; in order to adjust room humidity, the indoor unit's fan may stop from time to time. Also, the fan may operate at very low speed when adjusting room humidity.
- The fan speed cannot be changed manually when Dry mode has been selected.

Fan: ● Use to circulate the air throughout your room.

During Heating:

Set the temperature to a temperature setting that is higher than the present room temperature. The Heating mode will not operate if the temperature is set lower than the actual room temperature.

During Cooling/Dry:

Set the temperature to a temperature setting that is lower than the present room temperature. The Cooling and Dry modes will not operate if the temperature is set higher than the actual room temperature (in Cooling mode, the fan alone will operate).

During Fan:

You can not use the indoor unit to heat and cool your room.

TIMER OPERATION

Note for timer settings:

Any interruption of the power supply, such as a blackout or cutting off of a circuit breaker, makes the set internal clock go wrong.

In such a case, the TIMER indicator on the indoor unit blinks, and you need to readjust the setting.

TIMER OPERATION

To Use the ON timer or OFF timer

1 Turn on the indoor unit by pressing the START/STOP button. (Fig. 5 ①).

OPERATION indicator on the indoor unit turns on. If the indoor unit is already operating, skip this step.

2 Press the ON timer button (Fig. 5 ⑯) or the OFF timer button. (Fig. 5 ⑮).

Clock indicator on the remote controller display starts blinking, and TIMER indicator on the indoor unit turns on.

3 Adjust the time by pressing the SELECT button (Fig. 5 ⑰) within about 5 seconds, while the clock indicator is blinking.

(About 5 seconds later, the remote controller display returns to standby screen.) To cancel the timer and return to the normal operation, press the CANCEL button. To redo the timer setting, perform step 2 and 3.

To Use the PROGRAM timer

You can set an integrated ON-OFF or OFF-ON timer. Either of the timer whose configured starting time is closer to the current time works first, and the order of timer operation is displayed as follows:

Timer	Indicator on remote controller display
ON-OFF timer	ON▶OFF
OFF-ON timer	ON◀OFF

The timer that is set later starts counting down after the counting down of the preceding timer is finished.

Notes:

- If you change the setting value for the timer after the program timer is set, the counting down of the timer will be reset at that moment.
- Time setting for each combination should be within a span of 24 hours.

To Use the SLEEP timer

1 Press the SLEEP timer button (Fig. 5 ⑪) to activate the SLEEP timer.

OPERATION indicator and TIMER indicator on the indoor unit turns on.

2 Adjust the time by pressing the SELECT button (Fig. 5 ⑰) within about 5 seconds, while the clock indicator is blinking.

(About 5 seconds later, the remote controller display returns to standby screen.)

Each time you press the button, the time changes as follows:

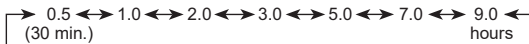

To repeat the timer, press the SLEEP timer button when SLEEP indicator is not displayed on the remote controller display.

To help you to fall asleep comfortably and prevent excessive warming or cooling in sleep, the SLEEP timer controls the temperature setting automatically in accordance with the set time shown as follows. The air conditioner completely turns off after the set time has elapsed.

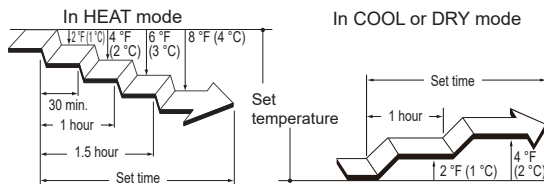

ADJUSTING THE DIRECTION OF AIR CIRCULATION

Vertical (up-down) direction of airflow is adjusted by pressing the Remote controller's SET button. Horizontal (right-left) airflow direction is adjusted manually, by moving the Airflow Direction Louvers.

Whenever making horizontal airflow adjustments, start air conditioner operation and be sure that the vertical air direction louvers are stopped.

Vertical Air Direction Adjustment

⚠ WARNING

- Never place fingers or foreign objects inside the outlet ports, since the internal fan operates at high speed and could cause personal injury.
- Always use the Remote controller's SET button to adjust the vertical airflow louvers. Attempting to move them manually could result in improper operation; in this case, stop operation and restart. The louvers should begin to operate properly again.
- When used in a room with infants, children, elderly or sick persons, the air direction and room temperature should be considered carefully when making settings.
- When indoor unit is embedded in a wall, airflow is fixed to horizontal direction ⑤. Please ask the service personnel to perform the embedding in a wall.

Press the SET button (Fig. 5 ⑩).

Each time the button is pressed, the air direction range will change as follows:



The Remote controller's display does not change.

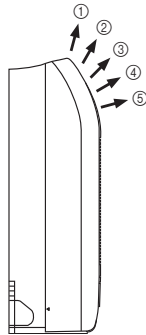

- Use the air direction adjustments within the ranges shown above.
- The vertical airflow direction is set automatically as shown, in accordance with the type of operation selected.
 - During Cooling/Dry mode : Upward flow ①
 - During Heating mode : Horizontal flow ④
- During AUTO mode operation, for the first minute after beginning operation, airflow will be upward ①; the air direction cannot be adjusted during this period.
- During Heating mode operation, airflow will be upward ① when the temperature of the air issued from the indoor is low.

Right-Left Adjustment

⚠ WARNING

- Always adjust the Right-Left louvers when the damper is open. Opening the damper forcibly with hands can cause damper malfunction.

Adjust the Right-Left louvers.

- Move the Right-Left louvers to adjust airflow in the direction you prefer.

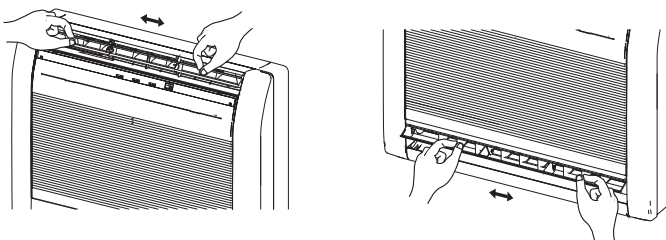

AIR OUTLET SELECTION

With this function, air comes out simultaneously from the upper and lower air outlets so that the room can be cooled or heated effectively. This function is set using the switch behind the front grille of the Indoor unit. (This function is available in cooling and heating operation.)

How to set to blow out air from the upper and lower air outlets

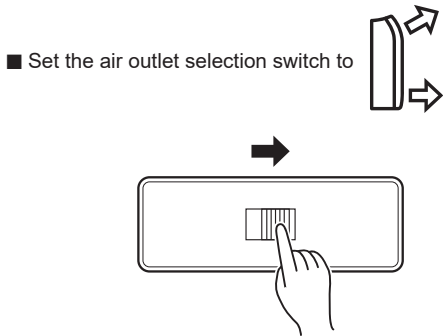





Air blows out automatically from the upper and lower air outlets as shown in the table below.

NOTE:

Set the air outlet selection switch to the end. Otherwise, air outlet cannot be selected as intended.

Description of operation

Operation	COOLING Mode		DRY Mode	HEATING Mode	
Airflow	 Upper and lower airflow	 Upper airflow	 Upper airflow only	 Upper and lower airflow	 Upper airflow
Conditions	Room temperature and set temperature are different.	Room temperature is close to set temperature, or the air conditioner has operated for 1 hour.	—	Airflow temperature is high.	Airflow temperature is low. (During defrosting operation, start of operation, etc.)

How to set to blow out air from the upper air outlet only

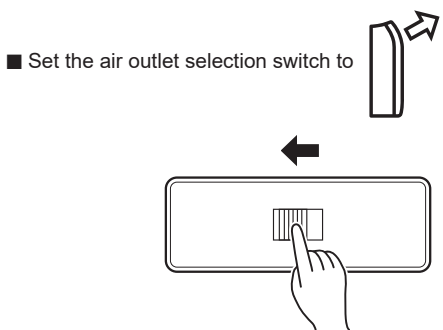

MIN. (MINIMUM) HEAT OPERATION

- The room temperature can be maintained at 50 °F (10 °C) by pressing the MIN. HEAT button (Fig.5 ⑥) so as to prevent the room temperature from falling too far.

To use MIN. HEAT OPERATION

Press the MIN. HEAT button (Fig. 5 ⑥)

The OPERATION Indicator lamp (green)(Fig.3 ⑥) will go out, and the ECONOMY Indicator lamp (green)(Fig. 3 ⑧) will light.

- The direction of airflow is set to horizontal.

While MIN. HEAT OPERATION is in progress, only the following operation can be used.

- SET

To stop MIN. HEAT OPERATION

Press the START/STOP button (Fig. 5 ①)

Then the operation stops.

● Indicator Lamp

TIMER OPERATION ECONOMY



● : Lighting ○ : OFF

About the MIN. HEAT OPERATION

Starts MIN. HEAT operation that maintains the room temperature at 50 °F (10 °C) so as to prevent the room temperature to drop too low.

When you press the button to start the MIN. HEAT operation, the indoor unit emits 2 short beeps and the ECONOMY indicator (green) turns on.

Notes:

- In MIN. HEAT operation mode, only vertical airflow direction can be adjusted by using SET button.
- HEAT mode will not be performed if the room temperature is warm enough.
- In multi-type air conditioning system, if other indoor unit is in HEAT mode, the temperature of the room where MIN. HEAT operation is performed will rise. When performing MIN. HEAT operation, all the indoor units should be run in MIN. HEAT operation mode. To return to normal operation, press the START/STOP button. The ECONOMY indicator turns off.

ECONOMY OPERATION

Begin Air Conditioner operation before performing this procedure.

To Use the ECONOMY Operation

Press the ECONOMY button (Fig.5 ⑱).

The OPERATION Indicator lamp (green)(Fig.3 ⑥) and the ECONOMY Indicator lamp (green)(Fig.3 ⑧) will light.

Economy operation begins.

● Indicator Lamp

TIMER OPERATION ECONOMY



● : Lighting ○ : OFF

To Stop the ECONOMY Operation

Press the ECONOMY button (Fig.5 ⑱) again.

The ECONOMY Indicator lamp (green)(Fig.3 ⑧) will go out.

Normal operation begins.

About ECONOMY Operation

Starts or stops ECONOMY operation that saves more electricity consumption than the other operations with a conservative adjustment of the room temperature. When you press the button, the ECONOMY indicator on the indoor unit turns on.

- In COOL or DRY mode, the room temperature will be adjusted at a few degree higher than the defined temperature.
- In HEAT mode, the room temperature will be adjusted at a few degree lower than the defined temperature.
- Especially in COOL or DRY mode, you can have improved dehumidification without significantly lowering the room temperature.

Notes:

- In COOL, HEAT, or DRY mode, the maximum output of this operation is approximately 70 % of usual air conditioning operation.
- This operation cannot be performed during temperature monitoring by AUTO mode.
- In multi-type air conditioning system, ECONOMY operation is performed only on the indoor unit whose ECONOMY button on the corresponding remote controller is pressed.

SWING OPERATION

Begin air conditioner operation before performing this procedure.

To select SWING Operation

Press the SWING button (Fig. 5 ⑨).

The SWING Display (Fig. 5 ㉔) will light.

In this mode, the Airflow Direction Louvers will swing automatically to direct the airflow both up and down.

To stop SWING Operation

Press the SWING button (Fig. 5 ⑨) once again.

The SWING Display (Fig. 5 ㉔) will go out.

Airflow direction will return to the setting before swing was begun.

About Swing Operation

Swings between ① and ⑤.

- The SWING operation may stop temporarily when the air conditioner's fan is not operating, or when operating at very low speeds.

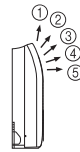

MANUAL AUTO OPERATION

Use the MANUAL AUTO operation in the event the Remote Controller is lost or otherwise unavailable.

How To Use the Main Unit Controls

Press the MANUAL AUTO button (Fig. 1 ③) more than 3 seconds and less than 10 seconds on the main unit control panel.

To stop operation, press the MANUAL AUTO button (Fig. 1 ③) for 3 seconds.

- When the air conditioner is operated with the controls on the Main Unit, it will operate under the same mode as the AUTO mode selected on the Remote Controller (see page 6).
- The fan speed selected will be "AUTO" and the temperature setting will be standard. (76 °F (24 °C))

POWERFUL OPERATION

How To Use the Main Unit Controls

The product will operate at maximum power, which is convenient when you want to quickly cool down or warm up the room.

When you press the button to start the POWERFUL operation, the indoor unit emits 3 short beeps.

POWERFUL operation is automatically turned off in the following situations:

- Adjusted room temperature reached to the defined temperature in temperature setting in COOL, DRY, or HEAT mode.
- 20 minutes have passed after finishing the POWERFUL operation mode setting. It is not turned off automatically during setting of the POWERFUL operation.

Notes:

- The airflow direction and the fan speed are controlled automatically.
- This operation cannot be performed simultaneously with ECONOMY operation.

To return to normal operation, press the button again. Then the indoor unit emits 2 short beeps.

CLEANING AND CARE

⚠ CAUTION

- Before cleaning the air conditioner, be sure to turn it off.
- Be sure the Intake Grille (Fig. 1 ⑨) is installed securely.
- When removing and replacing the air filter, be sure not to touch the heat exchanger, as personal injury may result.

Cleaning the Intake Grille

1. Remove the Intake Grille.

- ① Place your fingers at both top indicator of the grille panel, and pull forward; if the grille seems to catch partway through its movement, continue pulling down to remove.
- ② Unhook the ropes which holds the grille.

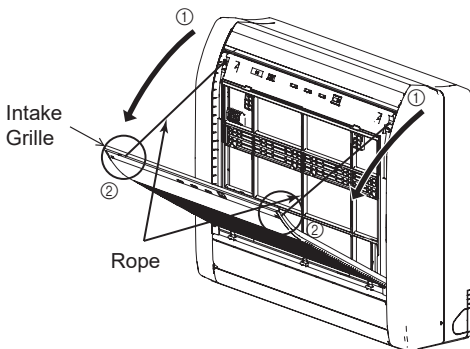

2. Clean with water.

Remove dust with a vacuum cleaner; wipe the unit with warm water, then dry with a clean, soft cloth.

3. Replace the Intake Grille.

- ① Hook the ropes.
- ② Set the left and right mounting shafts into the bearings at the bottom of the panel.
- ③ Press the place where the mark on the diagram indicates and close the Intake Grille.

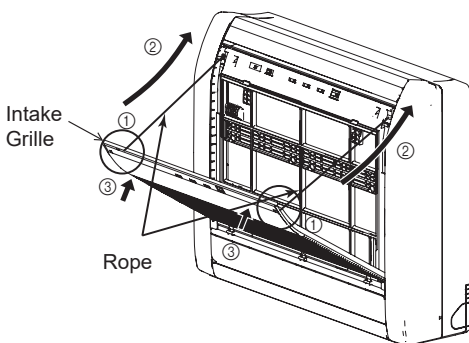

Cleaning the Air Filter

1. Open the Intake Grille, and remove the air filter.

Push down the air filter's handle, disconnect the 2 upper tabs, and pull out.

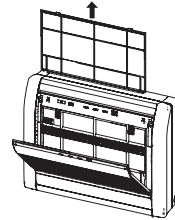

2. Remove dust with a vacuum cleaner or by washing.

After washing, allow to dry thoroughly in a shaded place.

3. Replace the Air Filter and close the Intake Grille.

- ① Align the sides of the air filter with the panel, and push in fully, making sure the 2 upper tabs are returned properly to their holes in the panel.

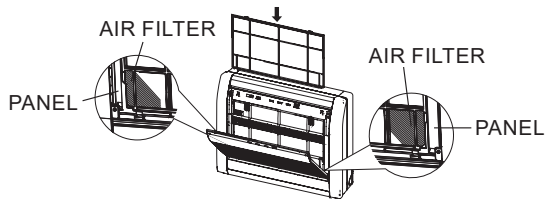

- ② Close the Intake Grille.

- Dust can be cleaned from the air filter either with a vacuum cleaner, or by washing the filter in a solution of mild detergent and warm water. If you wash the filter, be sure to allow it to dry thoroughly in a shady place before reinstalling.
- If dirt is allowed to accumulate on the air filter, airflow will be reduced, lowering operating efficiency and increasing noise.
- During periods of normal use, the Air Filters should be cleaned every 2 weeks.

- When used for extended periods, the unit may accumulate dirt inside, reducing its performance. We recommend that the unit be inspected regularly, in addition to your own cleaning and care. For more information, consult authorized service personnel.
- When cleaning the unit's body, do not use water hotter than 104 °F (40 °C), harsh abrasive cleansers, or volatile agents like benzene or thinner.
- Do not expose the unit body to liquid insecticides or hairsprays.
- When shutting down the unit for 1 month or more, first allow the fan mode to operate continuously for about one-half day to allow internal parts to dry thoroughly.

CLEANING AND CARE

Air Cleaning Filter Installation

1. Open the Intake Grille and remove the Air filter.



2. Install the Air cleaning filter set (set of 2).

Set the air cleaning filter into the panel.
Catch it on 5 places of picks.
(3 places of upper parts and lower part 2 places.)

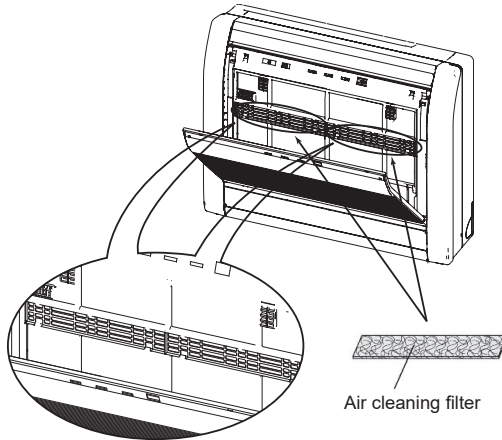

3. Install the Air filter and close the Intake Grille.

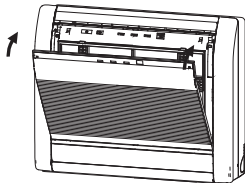

- When air cleaning filters are used, the effect will be increased by setting the fan speed to "High".

Replacing dirty Air cleaning filters

Replace filters with the following components (purchased separately).

- POLYPHENOL CATECHIN AIR CLEANING FILTER : UTR-FC03-2
- Negative air ions deodorizing filter: UTR-FC03-3

1. Open the Intake Grille and remove the Air filter.

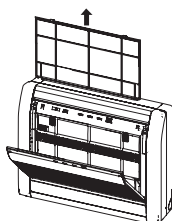

2. Replace them by 2 new Air cleaning filters.

- ① Remove the old air cleaning filters in reverse order of their installation.
- ② Install in the same way as for installation of the air cleaning filter set.

3. Install the Air filter and close the Intake Grille.

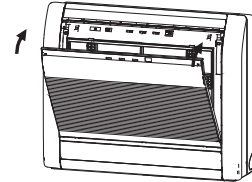

In regard to the Air Cleaning Filters

POLYPHENOL CATECHIN AIR CLEANING FILTER (1 sheet)

- The Air Cleaning Filters are disposable filters. (They can not be washed and reused.)
- For storage of the Air Cleaning Filters, use the filters as soon as possible after the package has been opened. (The air cleaning effect decreases when the filters are left in the opened package)
- Generally, the filters should be exchanged about every 3 months.

Please buy delicate air cleaning filters (UTR-FC03-2) (Sold separately) to exchange the used dirty air cleaning filters.

[Negative air ions deodorizing filter (1 sheet) — light blue]

- The filters should be exchanged about every 3 years so as to maintain the deodorizing effect.

Please buy delicate deodorizing filter (UTR-FC03-3) (Sold separately) when exchanging the filters.

Maintenance of Deodorizing Filters

In order to maintain the deodorizing effect, please clean the filter in the follow way once 3 months.

- ① Remove the deodorizing filter.
- ② Clean with water and dry in the air.
 - 1) Flush the filters with high-pressure hot water until the surface of the filters are covered with water. Please flush with diluent neutral detergent.

(Never wash by reaming or rubbing, otherwise it will damage the deodorizing effect.)
 - 2) Rinse with water flow.
 - 3) Dry in shade.
- ③ Reinstall the deodorizing filter.

Filter Indicator Reset (The special setting)

Can be used if set correctly during installation. Please consult authorized serviceman when using this function.

- It lights on when it is time to clean the air filters. Clean the filter referring to "CLEANING AND CARE". After cleaning, press the MANUAL AUTO button (Fig.2 ③) for 2 seconds or less on the indoor unit.

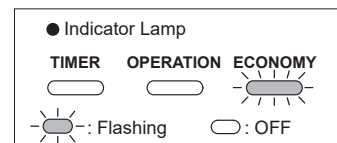

TROUBLESHOOTING

⚠ CAUTION

In the event of a malfunction (burning smell, etc.), immediately stop operation, turn off the electrical breaker or disconnect the power supply plug, and consult authorized service personnel.
 Merely turning off the unit's power switch will not completely disconnect the unit from the power source. Always be sure to turn off the electrical breaker or disconnect the power supply plug to ensure that power is completely off.

Before requesting service, perform the following checks:

	Symptom	Problem	See Page
NORMAL FUNCTION	Doesn't operate immediately:	<ul style="list-style-type: none"> ● If the unit is stopped and then immediately started again, the compressor will not operate for about 3 minutes, in order to prevent fuse blowouts. ● Whenever the electrical breaker is turned off than on again or the power supply plug is disconnected and then reconnected, the protection circuit will operate for about 3 minutes, preventing unit operation during that period. 	—
	Noise is heard:	<ul style="list-style-type: none"> ● During operation and immediately after stopping the unit, the sound of water flowing in the air conditioner's piping may be heard. Also, noise may be particularly noticeable for about 2 to 3 minutes after starting operation (sound of coolant flowing). ● During operation, a slight squeaking sound may be heard. This is the result of minute expansion and contraction of the front panel due to temperature changes. 	—
		<ul style="list-style-type: none"> ● During Heating operation, a sizzling sound may be heard occasional. This sound is produced by the Automatic Defrosting operation. 	18
	Smells:	<ul style="list-style-type: none"> ● Some smell may be emitted from the indoor unit. This smell is the result of room smells (furniture, tobacco, etc.) which have been taken into the indoor unit. 	—
	Mist or steam are emitted:	<ul style="list-style-type: none"> ● During Cooling or Dry operation, a thin mist may be seen emitted from the indoor unit. This results from the sudden Cooling of room air by the air emitted from the indoor unit, resulting in condensation and misting. 	—
		<ul style="list-style-type: none"> ● During Heating operation, the outdoor unit's fan may stop, and steam may be seen rising from the unit. This is due to Automatic Defrosting operation. 	18
	Airflow is weak or stops:	<ul style="list-style-type: none"> ● When Heating operation is started, fan speed is temporarily very low, to allow internal parts to warm up. ● During Heating operation, if the room temperature rises above the temperature setting, the outdoor unit will stop, and the indoor unit will operate at very low fan speed. If you wish to warm the room further, set the temperature for a higher setting. 	—
		<ul style="list-style-type: none"> ● During Heating operation, the unit will temporarily stop operation (for max. 15 minutes) as the Automatic Defrosting mode operates. During Automatic Defrosting operation, the OPERATION Indicator Lamp will flash. 	18
		<ul style="list-style-type: none"> ● The fan may operate at very low speed during Dry operation or when the unit is monitoring the room's temperature. 	6 - 7
		<ul style="list-style-type: none"> ● During SUPER QUIET operation, the fan will operate at very low speed. 	6
<ul style="list-style-type: none"> ● In the monitor AUTO operation, the fan will operate at very low speed. 		7	
<ul style="list-style-type: none"> ● In case of Multi-type unit, if multiple units are operated in different operation modes as shown below, the units operated afterward will stop and the OPERATION indicator lamp (green) will flash. Heating mode and cooling mode (or dry mode) Heating mode and fan mode 		19	
<ul style="list-style-type: none"> ● During Heating operation, water may be produced from the outdoor unit due to Automatic Defrosting operation. 		18	
Water is produced from the outdoor unit:	<ul style="list-style-type: none"> ● During Heating operation, water may be produced from the outdoor unit due to Automatic Defrosting operation. 	18	

TROUBLESHOOTING

	Symptom	Problem	See Page
NORMAL FUNCTION	The damper opens and closes automatically	<ul style="list-style-type: none"> ● The damper is automatically controlled by a microcomputer according to the airflow temperature and operation time of the air conditioner. 	—

	Symptom	Items to check	See Page
CHECK ONCE MORE	Doesn't operate at all:	<ul style="list-style-type: none"> ● Has the circuit breaker been turn off? ● Has there been a power failure? ● Has a fuse blown out, or a circuit breaker been tripped? 	—
		<ul style="list-style-type: none"> ● Is the timer operating? 	8 - 9
	Poor Cooling (or Heating) performance:	<ul style="list-style-type: none"> ● Is the Air Filter dirty? ● Are the air conditioner's intake grille or outlet port blocked? ● Did you adjust the room temperature settings (temperature) correctly? ● Is there a window or door open? ● In the case of Cooling operation, is a window allowing bright sunlight to enter? (Close the curtains.) ● In the case of Cooling operation, are there heating apparatus and computers inside the room, or are there too many people in the room? ● Make sure the lower air outlet is not choked with foreign matters, causing abnormal operation to damper. 	—
		<ul style="list-style-type: none"> ● Is the unit set for SUPER QUIET operation? 	6
The unit operates differently from the Remote controller's setting:	<ul style="list-style-type: none"> ● Are the Remote controller's batteries dead? ● Are the Remote controller's batteries loaded properly? 	5	

If the problem persists after performing these checks, or if you notice burning smells, or the OPERATION Indicator Lamp (Fig. 3 ⑥) and the TIMER Indicator Lamp (Fig. 3 ⑦) flashes, and ECONOMY Indicator Lamp (Fig.3 ⑧) flashes fast. Immediately stop operation, turn off the electrical breaker and consult authorized service personnel.

OPERATING TIPS

Operation and Performance

Heating Performance

- This air conditioner operates on the heat-pump principle, absorbing heat from outdoor air and transferring that heat indoors. As a result, the operating performance is reduced as outdoor air temperature drops. If you feel that insufficient heating performance is being produced, we recommend you use this air conditioner in conjunction with another kind of heating appliance.
- Heat-pump air conditioners heat your entire room by recirculating air throughout the room, with the result that some time may be required after first starting the air conditioner until the room is heated.

Microcomputer-controlled Automatic Defrosting

- When using the Heating mode under conditions of low outdoor temperature and high humidity, frost may form on the outdoor unit, resulting in reduced operating performance.
In order to prevent this kind of reduced performance, this unit is equipped with a Microcomputer-controlled Automatic Defrosting function. If frost forms, the air conditioner will temporarily stop, and the defrosting circuit will operate briefly (for max. 15 minutes).
During Automatic Defrosting operation, the OPERATION Indicator Lamp (green) will flash.
- After heating operation stops, if frost forms on the outdoor unit, the unit will start Automatic Defrosting operation. At this time, the outdoor unit will automatically stop after operating for a few minutes.
(However, some type of multi-type air conditioner doesn't provide this function.)

AUTO Restart

In Event of Power Interruption

- The air conditioner power has been interrupted by a power failure. The air conditioner will then restart automatically in its previous mode when the power is restored.
- If a power failure occurs during TIMER operation, the timer will be reset and the unit will begin (or stop) operation at the new time setting. In the event that this kind of timer fault occurs the TIMER Indicator Lamp will flash (see Page. 3).
- Use of other electrical appliances (electric shaver, etc.) or nearby use of a wireless radio transmitter may cause the air conditioner to malfunction. In this event, temporarily disconnect the Power Supply Plug, reconnect it, and then use the Remote Controller to resume operation.

OPERATING TIPS

Multi-type Air conditioner

This indoor unit can be connected to a multi-type outdoor unit. The multi-type air conditioner allows multiple indoor units to be operated in multiple locations. The indoor units may be operated simultaneously, in accordance with their respective output.

Simultaneous Use of Multiple Units

- When using a multi-type air conditioner, the multiple indoor units can be operated simultaneously, but when two or more indoor units of the same group are operated simultaneously, the heating and cooling efficiency will be less than when a single indoor unit is used alone. Accordingly, when you wish to use more than 1 indoor unit for cooling at the same time, the use should be concentrated at night and other times when less output is required. In the same way, when multiple units are used simultaneously for heating, it is recommended that they be used in conjunction with other auxiliary space heaters, as required.
- Seasonal and outdoor temperature conditions, the structure of the rooms and the number of persons present may also result in differences of operating efficiency. We recommend that you try various operating patterns in order to confirm the level of heating and cooling output provided by your units, and use the units in the way that best matches your family's lifestyle.
- If you discover that one or more units delivers a low level of cooling or heating during simultaneous operation, we recommend that you stop simultaneous operation of the multiple units.
- Operation cannot be done in the following different operating modes.
If the indoor unit is instructed to do an operating mode that it cannot perform, the OPERATION indicator lamp (green) on the indoor unit will flash (1 second on, 1 second off) and the unit will go into the standby mode.
 - Heating mode and cooling mode (or dry mode)
 - Heating mode and fan mode
- Operation can be done in the following different operating modes.
 - Cooling mode and dry mode
 - Cooling mode and fan mode
 - Dry mode and fan mode
- The operating mode (heating mode or cooling (dry) mode) of the outdoor unit will be determined by the operating mode of the indoor unit that was operated first. If the indoor unit was started in fan mode, the operating mode of the outdoor unit will not be determined.
For example, if indoor unit (A) was started in fan mode and then indoor unit (B) was then operated in heating mode, indoor unit (A) would temporarily start operation in fan mode but when indoor unit (B) started operating in heating mode, the OPERATION indicator lamp (green) for indoor unit (A) would begin to flash (1 second on, 1 second off) and it would go into standby mode. Indoor unit (B) would continue to operate in heating mode.

Notice

- During use of the heating mode, the outdoor unit will occasionally commence the defrost operation for brief periods. During the defrosting operation, if the user sets the indoor unit for heating again, the defrosting mode will continue, and the heating operation will begin after completion of defrosting, with the result that some time may be required before warm air is emitted.
- During use of the heating mode, the top of the indoor unit may become warm, but this is due to the fact that coolant is circulated through the indoor unit even when it is stopped; it is not a malfunction.